

*Exported to select countries as Amcron.*

# Studio Reference™

**PROFESSIONAL STUDIO AMPLIFIERS**

## OWNER'S MANUAL

©1995 by CROWN INTERNATIONAL, INC.  
 P.O. Box 1000, Elkhart, Indiana 46515-1000  
 Telephone: 219-294-8000



Printed on  
recycled paper.

**Trademark Notice:** *Studio Reference*,™ *Smart Amp*,™ *MPX-6*,™ *SMX-6*,™ *AMB-5*,™ and *grounded bridge*™ are trademarks and *Crown*,™ *IOC*,™ *ODEP*,™ *IQ System*™ and *P.I.P.*™ are registered trademarks of Crown International, Inc. Other trademarks are the property of their respective owners.

K80604-0  
8/95



# THREE YEAR FULL WARRANTY



## WORLDWIDE

### SUMMARY OF WARRANTY

The Crown Audio Division of Crown International, Inc., 1718 West Mishawaka Road, Elkhart, Indiana 46517-4095 U.S.A. warrants to you, the ORIGINAL PURCHASER and ANY SUBSEQUENT OWNER of each NEW Crown<sup>1</sup> product, for a period of three (3) years from the date of purchase by the original purchaser (the "warranty period") that the new Crown product is free of defects in materials and workmanship, and we further warrant the new Crown product regardless of the reason for failure, except as excluded in this Crown Warranty.

<sup>1</sup> Note: If your unit bears the name "Amcron," please substitute it for the name "Crown" in this warranty.

### ITEMS EXCLUDED FROM THIS CROWN WARRANTY

This Crown Warranty is in effect only for failure of a new Crown product which occurred within the Warranty Period. It does not cover any product which has been damaged because of any intentional misuse, accident, negligence, or loss which is covered under any of your insurance contracts. This Crown Warranty also does not extend to the new Crown product if the serial number has been defaced, altered, or removed.

### WHAT THE WARRANTOR WILL DO

We will remedy any defect, regardless of the reason for failure (except as excluded), by repair, replacement, or refund. We may not elect refund unless you agree, or unless we are unable to provide replacement, and repair is not practical or cannot be timely made. If a refund is elected, then you must make the defective or malfunctioning product available to us free and clear of all liens or other encumbrances. The refund will be equal to the actual purchase price, not including interest, insurance, closing costs, and other finance charges less a reasonable depreciation on the product from the date of original purchase. Warranty work can only be performed at our authorized service centers. We will remedy the defect and ship the product from the service center within a reasonable time after receipt of the defective product at our authorized service center. All expenses in remedying the defect, including surface shipping costs to the nearest authorized service center, will be borne by us. (You must bear the expense of all taxes, duties and other customs fees when transporting the product.)

### HOW TO OBTAIN WARRANTY SERVICE

You must notify us of your need for warranty service not later than ninety (90) days after expiration of the warranty period. All components must be shipped in a factory pack. Corrective action will be taken within a reasonable time of the date of receipt of the defective product by our authorized service center. If the repairs made by our authorized service center are not satisfactory, notify our authorized service center immediately.

### DISCLAIMER OF CONSEQUENTIAL AND INCIDENTAL DAMAGES

YOU ARE NOT ENTITLED TO RECOVER FROM US ANY INCIDENTAL DAMAGES RESULTING FROM ANY DEFECT IN THE NEW CROWN PRODUCT. THIS INCLUDES ANY DAMAGE TO ANOTHER PRODUCT OR PRODUCTS RESULTING FROM SUCH A DEFECT.

### WARRANTY ALTERATIONS

No person has the authority to enlarge, amend, or modify this Crown Warranty. This Crown Warranty is not extended by the length of time which you are deprived of the use of the new Crown product. Repairs and replacement parts provided under the terms of this Crown Warranty shall carry only the unexpired portion of this Crown Warranty.

### DESIGN CHANGES

We reserve the right to change the design of any product from time to time without notice and with no obligation to make corresponding changes in products previously manufactured.

### LEGAL REMEDIES OF PURCHASER

No action to enforce this Crown Warranty shall be commenced later than ninety (90) days after expiration of the warranty period.

**THIS STATEMENT OF WARRANTY SUPERSEDES ANY OTHERS CONTAINED IN THIS MANUAL FOR CROWN PRODUCTS.**

Telephone: 219-294-8200. Facsimile: 219-294-8301 9/90

## NORTH AMERICA

### SUMMARY OF WARRANTY

The Crown Audio Division of Crown International, Inc., 1718 West Mishawaka Road, Elkhart, Indiana 46517-4095 U.S.A. warrants to you, the ORIGINAL PURCHASER and ANY SUBSEQUENT OWNER of each NEW Crown product, for a period of three (3) years from the date of purchase by the original purchaser (the "warranty period") that the new Crown product is free of defects in materials and workmanship, and we further warrant the new Crown product regardless of the reason for failure, except as excluded in this Crown Warranty.

### ITEMS EXCLUDED FROM THIS CROWN WARRANTY

This Crown Warranty is in effect only for failure of a new Crown product which occurred within the Warranty Period. It does not cover any product which has been damaged because of any intentional misuse, accident, negligence, or loss which is covered under any of your insurance contracts. This Crown Warranty also does not extend to the new Crown product if the serial number has been defaced, altered, or removed.

### WHAT THE WARRANTOR WILL DO

We will remedy any defect, regardless of the reason for failure (except as excluded), by repair, replacement, or refund. We may not elect refund unless you agree, or unless we are unable to provide replacement, and repair is not practical or cannot be timely made. If a refund is elected, then you must make the defective or malfunctioning product available to us free and clear of all liens or other encumbrances. The refund will be equal to the actual purchase price, not including interest, insurance, closing costs, and other finance charges less a reasonable depreciation on the product from the date of original purchase. Warranty work can only be performed at our authorized service centers or at the factory. We will remedy the defect and ship the product from the service center or our factory within a reasonable time after receipt of the defective product at our authorized service center or our factory. All expenses in remedying the defect, including surface shipping costs in the United States, will be borne by us. (You must bear the expense of shipping the product between any foreign country and the port of entry in the United States and all taxes, duties, and other customs fees for such foreign shipments.)

### HOW TO OBTAIN WARRANTY SERVICE

You must notify us of your need for warranty service not later than ninety (90) days after expiration of the warranty period. All components must be shipped in a factory pack, which, if needed, may be obtained from us free of charge. Corrective action will be taken within a reasonable time of the date of receipt of the defective product by us or our authorized service center. If the repairs made by us or our authorized service center are not satisfactory, notify us or our authorized service center immediately.

### DISCLAIMER OF CONSEQUENTIAL AND INCIDENTAL DAMAGES

YOU ARE NOT ENTITLED TO RECOVER FROM US ANY INCIDENTAL DAMAGES RESULTING FROM ANY DEFECT IN THE NEW CROWN PRODUCT. THIS INCLUDES ANY DAMAGE TO ANOTHER PRODUCT OR PRODUCTS RESULTING FROM SUCH A DEFECT. **SOME STATES DO NOT ALLOW THE EXCLUSION OR LIMITATIONS OF INCIDENTAL OR CONSEQUENTIAL DAMAGES, SO THE ABOVE LIMITATION OR EXCLUSION MAY NOT APPLY TO YOU.**

### WARRANTY ALTERATIONS

No person has the authority to enlarge, amend, or modify this Crown Warranty. This Crown Warranty is not extended by the length of time which you are deprived of the use of the new Crown product. Repairs and replacement parts provided under the terms of this Crown Warranty shall carry only the unexpired portion of this Crown Warranty.

### DESIGN CHANGES

We reserve the right to change the design of any product from time to time without notice and with no obligation to make corresponding changes in products previously manufactured.

### LEGAL REMEDIES OF PURCHASER

THIS CROWN WARRANTY GIVES YOU SPECIFIC LEGAL RIGHTS, YOU MAY ALSO HAVE OTHER RIGHTS WHICH VARY FROM STATE TO STATE. No action to enforce this Crown Warranty shall be commenced later than ninety (90) days after expiration of the warranty period.

**THIS STATEMENT OF WARRANTY SUPERSEDES ANY OTHERS CONTAINED IN THIS MANUAL FOR CROWN PRODUCTS.**

Telephone: 219-294-8200. Facsimile: 219-294-8301 9/90

The information furnished in this manual does not include all of the details of design, production, or variations of the equipment. Nor does it cover every possible situation which may arise during installation, operation or maintenance. If your unit bears the name "Amcron," please substitute it for the name "Crown" in this manual. If you need special assistance beyond the scope of this manual, please contact our Technical Support Group.

### **Crown Audio Division Technical Support Group**

57620 C.R. 105, Elkhart, Indiana 46517 U.S.A.

Phone: **800-342-6939** (U.S.A.) or 219-294-8200 Fax: 219-294-8301

## **IMPORTANT**

**STUDIO REFERENCE AMPLIFIERS  
REQUIRE CLASS 1 OUTPUT WIRING.**

### **CAUTION**

**RISK OF ELECTRIC SHOCK  
DO NOT OPEN**

**TO PREVENT ELECTRIC SHOCK DO NOT REMOVE TOP OR BOTTOM COVERS. NO USER SERVICEABLE PARTS INSIDE. REFER SERVICING TO QUALIFIED SERVICE PERSONNEL. DISCONNECT POWER CORD BEFORE REMOVING REAR INPUT MODULE TO ACCESS GAIN SWITCH.**

### **AVIS**

**RISQUE DE CHOC ÉLECTRIQUE  
N'OUVREZ PAS**

**À PRÉVENIR LE CHOC ÉLECTRIQUE N'ENLEVEZ PAS LES COUVERTURES. RIEN DES PARTIES UTILES À L'INTÉRIEUR. DÉBRANCHER LA BORNE AVANT D'OUVRIR LA MODULE EN ARRIÈRE.**



## **WARNING**

**TO REDUCE THE RISK OF ELECTRIC SHOCK, DO NOT EXPOSE THIS EQUIPMENT TO RAIN OR MOISTURE!**

### **Magnetic Field**

**CAUTION! Do not locate sensitive high-gain equipment such as preamplifiers or tape decks directly above or below the unit.** Because this amplifier has a high power density, it has a strong magnetic field which can induce hum into unshielded devices that are located nearby. The field is strongest just above and below the unit.

If an equipment rack is used, we recommend locating the amplifier(s) in the bottom of the rack and the preamplifier or other sensitive equipment at the top.

### **WATCH FOR THESE SYMBOLS:**



The lightning bolt triangle is used to alert the user to the risk of electric shock.



The exclamation point triangle is used to alert the user to important operating or maintenance instructions.

# CONTENTS

<b>1</b>	<b>Welcome</b> .....	<b>7</b>
1.1	Features .....	7
<b>2</b>	<b>Facilities</b> .....	<b>8</b>
<b>3</b>	<b>Installation</b> .....	<b>10</b>
3.1	Mounting .....	10
3.2	Cooling .....	10
3.3	Wiring .....	11
3.3.1	Stereo (Two-Channel) Operation .....	12
3.3.2	Bridge-Mono Operation .....	12
3.3.3	Parallel-Mono Operation .....	13
3.3.4	Input Connection .....	14
3.3.5	Output Connection .....	16
3.3.6	Additional Load Protection .....	18
3.4	AC Mains Power .....	18
<b>4</b>	<b>Operation</b> .....	<b>19</b>
4.1	Precautions .....	19
4.2	Indicators .....	19
4.3	Protection Systems .....	20
4.3.1	ODEP .....	21
4.3.2	Standby Mode .....	21
4.3.3	Transformer Thermal Protection .....	21
4.3.4	Circuit Breaker .....	22
4.4	Controls .....	22
4.5	Filter Cleaning .....	23
<b>5</b>	<b>Technical Information</b> .....	<b>24</b>
5.1	Overview .....	24
5.2	Circuit Theory .....	24
5.2.1	Stereo Operation .....	24
5.2.2	Bridge-Mono Operation .....	26
5.2.3	Parallel-Mono Operation .....	26
<b>6</b>	<b>Specifications</b> .....	<b>27</b>
<b>7</b>	<b>AC Power Draw &amp; Thermal Dissipation</b> .....	<b>36</b>
<b>8</b>	<b>Accessories</b> .....	<b>38</b>
8.1	P.I.P. Modules .....	38
<b>9</b>	<b>Service</b> .....	<b>40</b>
9.1	Worldwide Service .....	40
9.2	North American Service .....	40
9.2.1	Service at a North American Service Center ..	40
9.2.2	Factory Service .....	40

## ILLUSTRATIONS

1.1	Studio Reference I Amplifier .....	6
2.1	Front Facilities .....	8
2.2	Rear Facilities .....	9
3.1	Mounting Dimensions .....	10
3.2	Removing an End Cap .....	10
3.3	Top View of a Rack-Mounted Unit .....	10
3.4	Proper Air Flow with a Rack-Mounted Blower .....	11
3.5	Stereo Wiring .....	11
3.6	Bridge-Mono Wiring .....	12
3.7	Parallel-Mono Wiring .....	13
3.8	Unbalanced Input Wiring .....	14
3.9	Balanced Input Wiring .....	14
3.10	Balanced and Unbalanced Phone Plugs .....	14
3.11	Subsonic Filter Capacitors .....	15
3.12	Unbalanced RF Filters .....	15
3.13	Balanced RF Filters .....	15
3.14	Wire Size Nomograph .....	16
3.15	Inductive Load (Transformer) Network .....	17
3.16	Loudspeaker Fuse Nomograph .....	18
4.1	Indicators .....	19
4.2	Studio Reference Indicator States .....	20
4.3	Removing a Handle .....	22
4.4	Meter Switches .....	23
4.5	Input Sensitivity and Ground Lift Switches .....	23
5.1	Circuit Block Diagram .....	25
6.1	Studio Reference I Minimum Power Matrix .....	29
6.2	Studio Reference II Minimum Power Matrix .....	30
6.3	Studio Reference I Maximum Power Matrix .....	31
6.4	Studio Reference II Maximum Power Matrix .....	32
6.5	Typical Frequency Response .....	33
6.6	Typical Damping Factor .....	33
6.7	Typical Output Impedance .....	33
6.8	Typical Phase Response .....	34
6.9	Typical Common Mode Rejection .....	34
6.10	Typical Crosstalk .....	35
7.1	Studio Reference I Power Draw, Current Draw and Thermal Dissipation at Various Duty Cycles .....	36
7.2	Studio Reference II Power Draw, Current Draw and Thermal Dissipation at Various Duty Cycles .....	37
8.1	Installing a P.I.P. Module .....	38



Fig. 1.1 Studio Reference I Amplifier

### Unpacking Instructions

Please unpack and inspect your new amplifier for any damage that may have occurred during transit. If damage is found, notify the transportation company immediately. Only you, the consignee, may initiate a claim for shipping damage. Crown will be happy to cooperate fully as needed. Save the shipping carton as evidence of damage for the shipper's inspection.

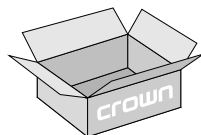

Even if the unit arrived in perfect condition, as most do, save all packing materials so you will have them if you ever need to transport the unit. **NEVER SHIP THE UNIT WITHOUT THE FACTORY PACK.**

# 1 Welcome

The stunning realism you will experience when listening to a Crown *Studio Reference*™ amplifier will redefine your expectations. The evolution of this studio standard ushers in a new era of powerful, ultraquiet amplifiers capable of faithfully reproducing the most demanding signals that state-of-the-art 20-bit digital recording systems can offer. This kind of sonic integrity does not happen accidentally. It demands the leadership and technical excellence for which Crown has long been known.

With the best transfer function in the industry, ultra-high dynamic range and extraordinary damping factor, your *Studio Reference* amplifier comes closer to the ideal “straight wire with gain” than any other amplifier. As you listen, it will become apparent—the amplifier’s low-frequency transient response is the standard by which all others must be judged.

We have taken great care at every step in the creation of your amplifier—from the selection of its components to the routing of each wire. It is our goal to provide you with total satisfaction. This is one reason why we have spent considerable effort in providing you with the most complete *Owner’s Manual* in the business. Please read it carefully—especially the instructions, warnings and cautions. It will help you successfully install and use your new amplifier. Be sure to read Sections 3.3.2 and 3.3.3 if you plan to use one of the amplifier’s two mono modes.

Please send in your warranty registration card today and save your bill of sale because it is your official proof of purchase. We hope you enjoy your new amplifier, and thank you for choosing Crown.

## 1.1 Features

*Studio Reference* amplifiers integrate several cutting edge technologies that make them the most accurate reference amplifiers available. For example, in Stereo mode each channel can actually be treated as a separate amplifier because of its separate high-voltage power supplies and ultra-low crosstalk. Here are some of its many impressive features:

- ❑ Crown’s unconventional *grounded bridge*™ circuitry delivers incredible voltage swings without using stressful output transistor configurations like other more

traditional amplifiers. This results in significantly lower distortion and superior reliability.

- ❑ Patented *ODEP*® (Output Device Emulation Protection) circuitry detects and compensates for overheating and overload to keep the amplifier working when others would fail.
- ❑ *IOC*® (Input/Output Comparator) circuitry immediately alerts you of any distortion that exceeds 0.05% to provide dynamic *proof of distortion-free performance*.
- ❑ *P.I.P.* (Programmable Input Processor) connector accepts accessories that tailor your amplifier to suit specific applications.
- ❑ Extremely wide dynamic range capable of accurately reproducing 20-bit digital recordings.
- ❑ Ultra-high damping factor delivers superior loudspeaker motion control for the cleanest, tightest, chest-thumping bottom end you’ve ever felt—or heard.
- ❑ Super-low harmonic and intermodulation distortion give your amplifier *the best transfer function* in the business.
- ❑ Two mono modes (Bridge-Mono and Parallel-Mono) for driving a wide range of load impedances.
- ❑ Custom-designed, tape-wound, low-noise toroidal supplies with extremely high power density.
- ❑ High-voltage headroom and high-current headroom provide energy reserves that make it easy to drive low-impedance loads and highly reactive loads to full power.
- ❑ Full protection against shorted outputs, mismatched loads, general overheating, DC and high-frequency overloads. Full overvoltage and internal fault protection.
- ❑ Indicators include Enable, *ODEP*, *IOC*, Signal Presence and the Dynamic Range/Level meter.
- ❑ Balanced phone jacks and XLR connectors are provided for input. Two pair of 5-way binding posts per channel are provided for versatile output connection.
- ❑ Ground lift switch isolates the AC power and phone jack audio grounds.
- ❑ Efficient heat sinks and a self-contained, on-demand, infinitely variable forced-air cooling system prevents overheating and prolongs component life.
- ❑ Internal three-position input sensitivity switch provides settings of 0.775 volts and 1.4 volts for standard 1 kHz power, and 26 dB gain.
- ❑ Mounts in a standard 19 inch (48.3 cm) equipment rack, or units can be stacked directly on top of each other.
- ❑ Three year “No-Fault” full warranty completely protects your investment and guarantees its specifications.

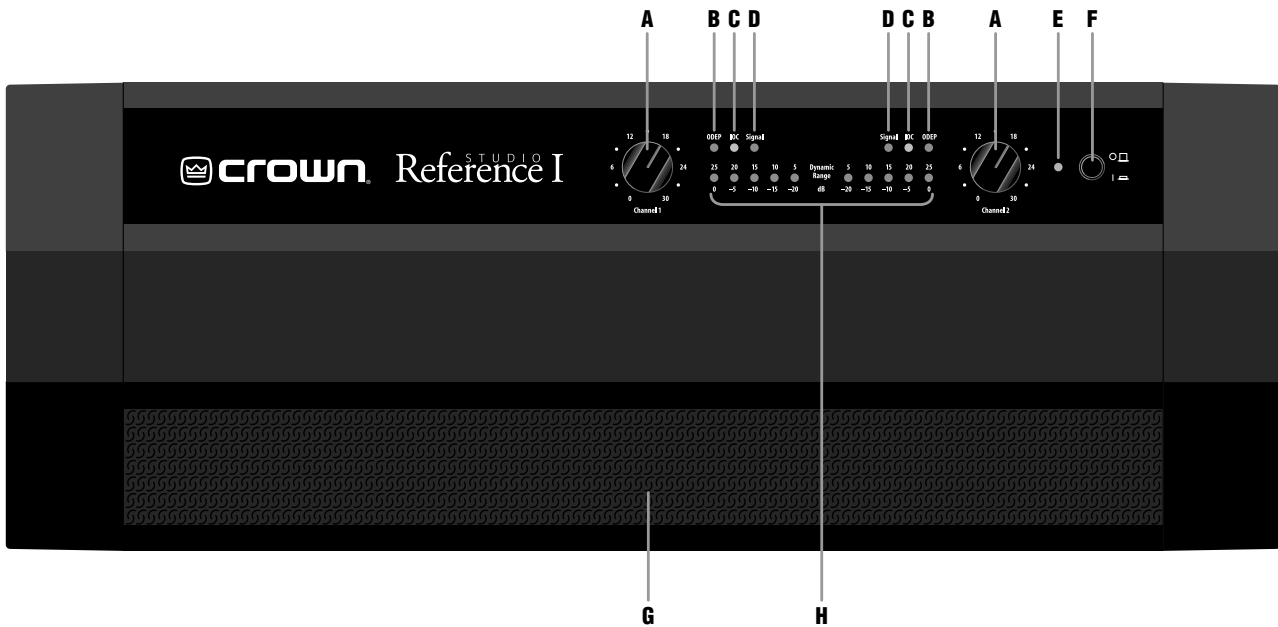

Fig. 2.1 Front Facilities

## 2 Facilities

### A. Level Controls

Each channel's output level can be adjusted accurately using the 31-position detented level controls on the front panel (see Section 4.4).

### B. ODEP Indicators

During normal operation of the amplifier, the *ODEP* (Output Device Emulation Protection) indicators glow brightly to show the presence of reserve thermodynamic energy. They dim proportionally as energy reserves decrease. In the rare event that energy reserves are depleted, the indicators turn off and *ODEP* proportionally limits the output drive so the amplifier can safely continue operating even under severe conditions. These indicators also help to identify more unusual operating conditions (see Figure 4.2).

### C. IOC Indicators

The *IOC* (Input Output Comparator) indicators serve as sensitive distortion indicators to provide *proof of distortion-free performance*. Under normal conditions, the indicators remain off. They flash if the output waveform differs from the input by 0.05% or more (see Section 4.2). If the input signal level is too high, the indicators will also flash brightly with a half-second hold delay to show input overload or output clipping. *Note: The channel 2 IOC indicator stays on in Parallel-Mono mode.* See Section 4.2.

### D. Signal Presence Indicators

These indicators flash synchronously with the amplifier's audio output to show signal presence. *Note: These indi-*

*cators may not flash at very low input signal levels.* See Section 4.2.

### E. Enable Indicator

This indicator lights when the amplifier has been “enabled” or turned on, and AC power is available.

### F. Enable Switch

This push button is used to turn the amplifier on and off. When turned on, the output is muted for about four seconds to protect your system from start-up transients. This is why a power sequencer is rarely needed for multiple units. (The turn-on delay can be changed. Contact Crown's Technical Support Group for details.)

### G. Dust Filter

The dust filter removes large particles from the air drawn in by the cooling fan. In most cases, the fan will not run so the filter will remain clean. If the filter becomes dirty, it can be removed for easy cleaning (see Section 4.5).

### H. Dynamic Range / Level Meters

A five-segment output meter is provided for each channel. The meters are factory-set to show dynamic range of the signals in dB, which is computed as the ratio of peak to average output power. Also, the meter can optionally be set to show output levels (see Section 4.4).

### □ Meter Switches

Two switches behind the front panel can be used to customize the output meters (H). By default, the meters display dynamic range. To make the meters display signal levels or to turn them off, see Section 4.4.



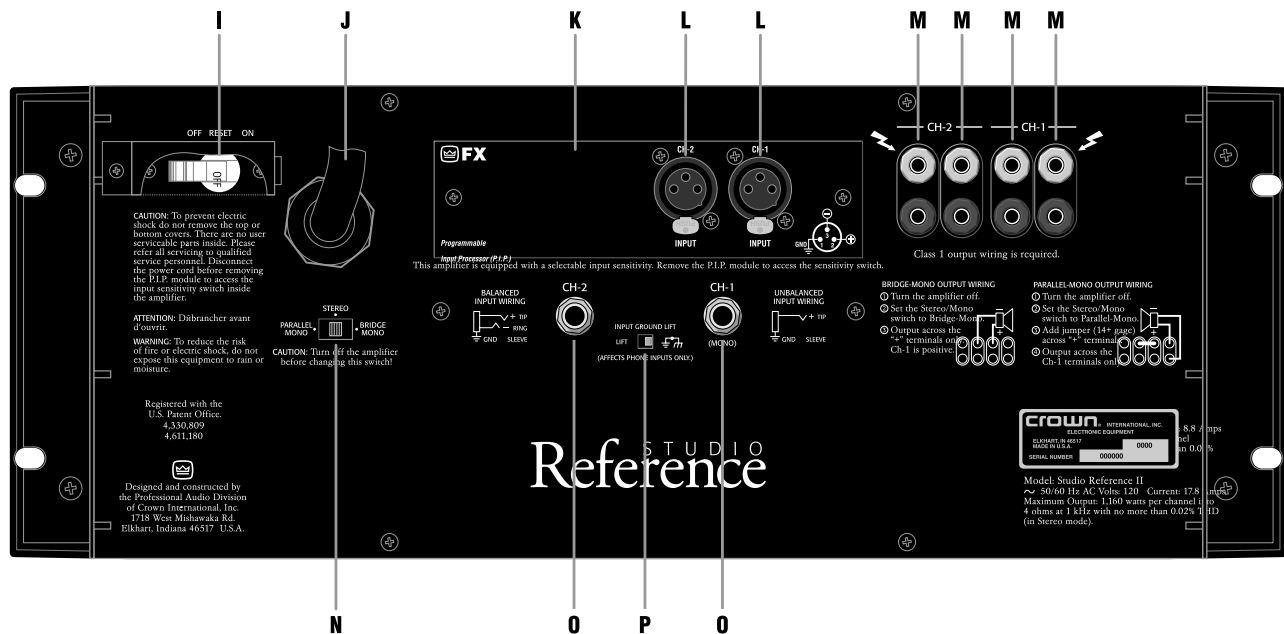

Fig. 2.2 Rear Facilities

### I. Reset Switch

This back panel switch can be used to trip and reset the AC mains circuit breaker (see Section 4.3.4).

### J. Power Cord

For 120 VAC, 60 Hz North American units, the *Studio Reference I* includes a 10 AWG power cord and NEMA TT30P plug, and the *Studio Reference II* includes a 12 AWG cord and NEMA 5-15P plug. Other units are shipped with an appropriate power cord and plug.

### K. P.I.P. Module

The standard P.I.P.-FX input module is provided with your amplifier. It provides female XLR input connectors. Each pair of XLR and phone jack connectors is wired in parallel so the unused connector can be used as a “daisy chain” output to connect a source to multiple amplifiers. Other P.I.P. modules can be used in place of the P.I.P.-FX to provide additional features that customize your amplifier for different applications (see Section 8 for available P.I.P. modules).

### L. Balanced XLR Inputs

A balanced three-pin female XLR connector is provided on the P.I.P.-FX (K) for input to each channel. **Caution:** **Do not use the channel 2 input in either mono mode.**

### M. Output Connectors

Two pairs of versatile 5-way binding posts are provided for the output of each channel so multiple loudspeakers can be connected easily. They accept banana plugs, spade lugs or bare wire.

### N. Stereo/Mono Switch

This switch is used to select one of three operating modes. Stereo mode is used for normal two-channel operation, Bridge-Mono mode is used to drive a single channel with a load impedance of at least 4 ohms, and Parallel-Mono mode is used to drive a single channel with a load impedance of less than 4 ohms. **WARNING:** **Turn off the amplifier before changing this switch (see Section 3.3).**

### O. Balanced Phone Jack Inputs

A balanced 1/4-inch phone jack is provided for input to each channel. They may be used with either balanced (tip, ring and sleeve) or unbalanced (tip and sleeve) input wiring (see Section 3.3). These inputs are in parallel with the P.I.P. connector, so they should not be used as inputs if the installed P.I.P. has active circuitry. **Caution:** **Do not use the channel 2 input in either mono mode.**

### P. Ground Lift Switch

The input signal ground may be isolated from the AC ground with this switch to help prevent unwanted ground loops. It affects only the phone jacks (O). It has no effect on the P.I.P. module’s XLR connectors. Activating the switch inserts an impedance between the sleeve of each phone input jack and the circuit ground.

### Q. Input Sensitivity Switch

The three-position input sensitivity switch inside the amplifier can be accessed by removing the P.I.P. module. Settings include 0.775 volts and 1.4 volts for rated output, and 26 dB voltage gain (see Section 4.4).



### 3 Installation

#### 3.1 Mounting

Studio Reference amplifiers are designed for standard 19 inch (48.3 cm) rack mounting or stacking without a cabinet. In a rack, it is best to mount units directly on top of each other. This provides the most efficient air flow and support. If the rack will be transported, we recommend that you fasten the amplifier's back panel securely to the rack to help support the unit's weight.

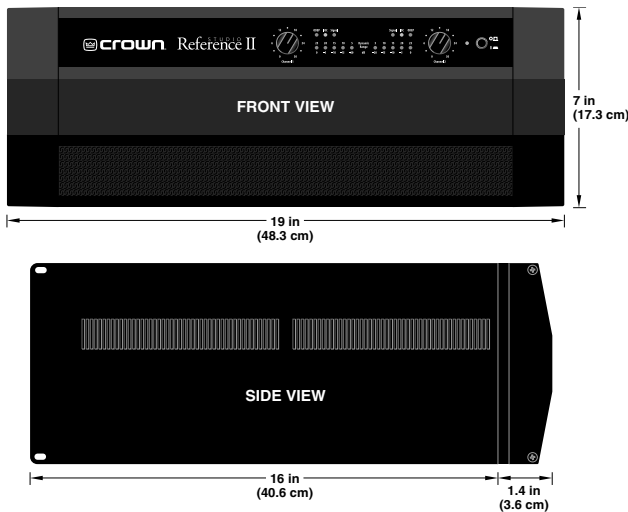

Fig. 3.1 Mounting Dimensions

Before proceeding, make sure the meter switches are set to your liking. The front panel assembly must first be removed to change these switches, so it is easier to do before the unit is mounted (see Section 4.4).

By now, you may be looking for rack ears. The rack ears are covered by two attractive end caps which are held in place by phillips screws (see Figure 3.2). To use the rack ears, remove the screws and lift off the caps. With sufficient side clearance, you can reinstall the end caps once the amplifier is mounted in the rack.

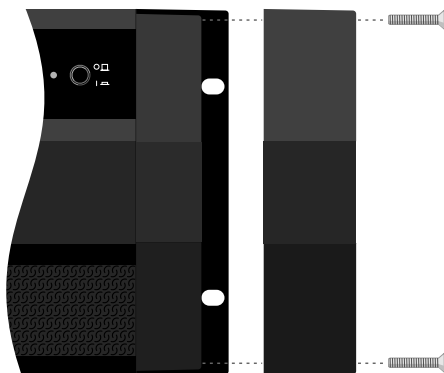

Fig. 3.2 Removing an End Cap

#### 3.2 Cooling

Your amplifier has an internal variable speed fan that is controlled to match the unit's real-time cooling needs. With proper installation and typical studio use, the fan may never need to run. For best results, you should familiarize yourself with its cooling requirements.

Here are some tips to help keep your amplifier cool. First, never block the amplifier's front or side air vents. If the amplifier is rack-mounted, its sides should be at least 2 inches (5 cm) away from the cabinet (see Figure 3.3). Also, open rack spaces should be covered to prevent heated air from the side vents from being drawn out the front of the rack into the front air intake.

You will know when your Studio Reference amplifier has sufficient cooling because its ODEP indicators will be brightly lit. If the amplifier's ODEP indicators dim or turn off, overly demanding conditions are forcing it to protect itself from overheating. If you experience a cooling problem, you should consider several factors that may be contributing to the problem, including load impedance, air flow and ambient air temperature.

Low-impedance loads generate more heat than higher impedance loads. To avoid impedance-related cooling problems, connect loads to each channel with a total impedance of at least 2 ohms in Stereo, 4 ohms in Bridge-Mono, and 1 ohm in Parallel-Mono mode (see Section 3.3 for wiring instructions). If your loads are reasonable and you still have a cooling problem, check for shorts in the loudspeaker cables, and look for problems with air flow or ambient air temperature.

Air flow restrictions are the most common cause of inadequate cooling. Restrictions may result from improper

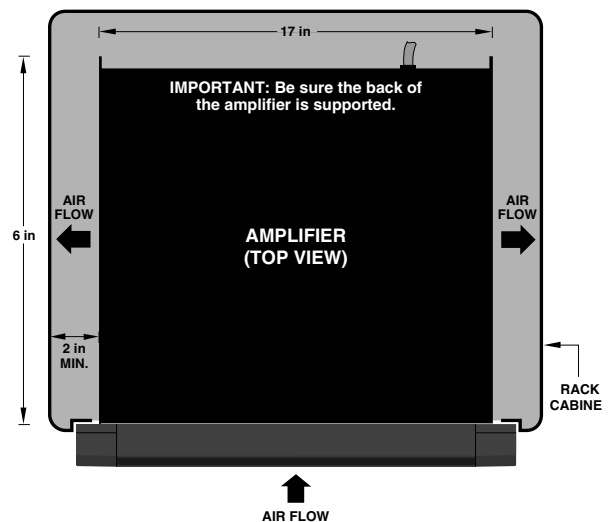

Fig. 3.3 Top View of a Rack-Mounted Unit

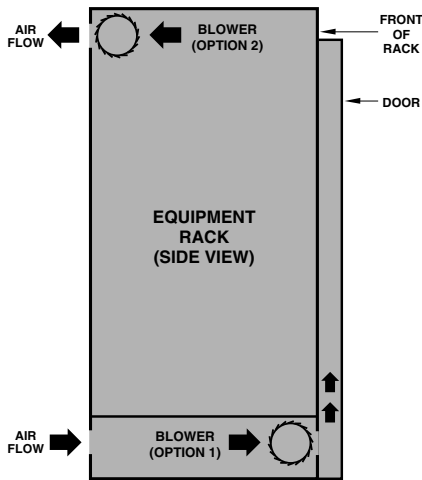

Fig. 3.4 Proper Air Flow with a Rack-Mounted Blower

mounting, piles of power cords, clogged dust filters and closed rack doors. Mount your amplifier to allow sufficient air flow into the front intake, out the side exhaust vents, and out the back of the rack. An air flow restriction like a pile of power cords can simply be moved out of the way. Air filters should be cleaned using the procedure in Section 4.5. If rack doors are the problem, you can leave them open, remove them, or install a grille. If you install a grille, we recommend using a wire grille because perforated panels restrict air flow by at least 40%.

If your ODEP indicators still dim under demanding conditions, we recommend that you check the table of indicator states in Figure 4.2 to eliminate other conditions that could be the source of the problem. If it is clear that the amplifier does not have sufficient air flow,

you may want to install supplemental cooling like a rack-mounted blower or an air conditioner.

A “squirrel cage” blower can be installed at the bottom of the rack so it blows outside air into the space between the door and the front of the amplifiers. This will pressurize the “chimney” behind the door (Figure 3.4, Option 1). The blower should not blow air into or take air out of the space behind the amplifiers. For racks without a front door, you can evacuate the rack by mounting the blower at the top of the rack so air blows out the back (Figure 3.4, Option 2). You can estimate a rack’s required air flow by adding each unit’s maximum air flow rating. The *Studio Reference I* and *II* can each move up to 45 cubic feet (1.3 cubic meters) of air per minute. So if you put one of each in a rack, you would need 90 cubic feet (2.5 cubic meters) of air flow through the rack per minute under worst-case conditions (45 cubic feet + 45 cubic feet = 90 cubic feet).

Another way to increase cooling is to use air conditioning. It is rarely a necessity because internal fans and rack-mounted blowers almost always provide enough air flow for the most extreme conditions. Still, air conditioning helps reduce the ambient temperature of the air flowing through the rack. If you plan to use air conditioning, refer to Section 7 for information on calculating the hourly thermal dissipation of your system.

### 3.3 Wiring

Figures 3.5 through 3.7 show common ways to set up a *Studio Reference* amplifier. Input and output connectors are located on the back panel. Be careful when

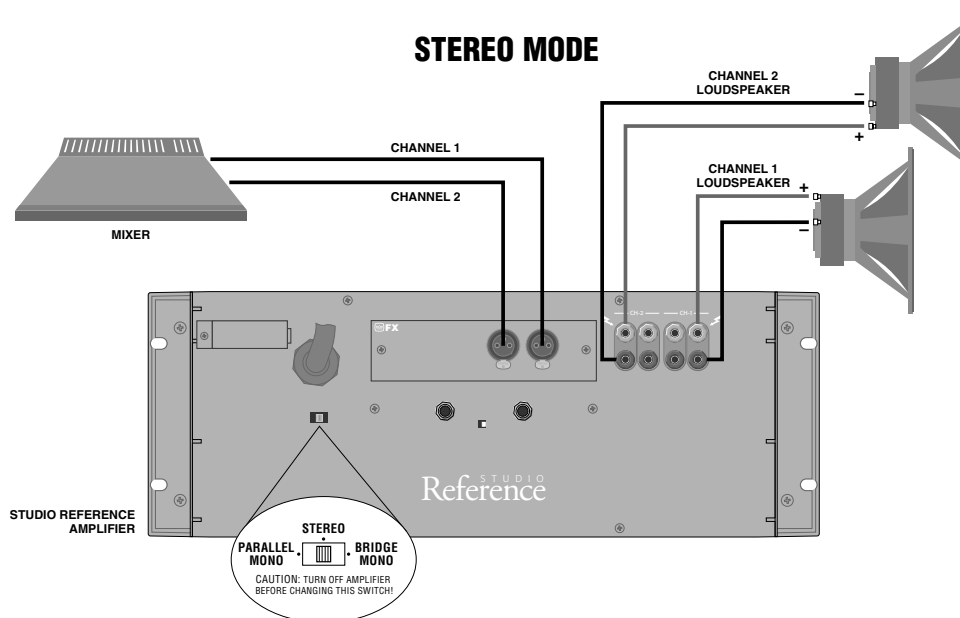

Fig. 3.5 Stereo Wiring

making connections, selecting sources and controlling output levels. The load you save may be your own! Crown is not responsible for damaged loads that result from carelessness or deliberate overpowering.

**CAUTION:** Always disconnect the AC power and turn the level controls down when making or breaking connections. This practice reduces the chance of loud blasts that can cause loudspeaker damage.

Studio Reference amplifiers provide three operating modes: Stereo, Bridge-Mono and Parallel-Mono. Stereo mode provides standard two-channel operation; Bridge-Mono provides a single channel with double the output voltage of Stereo mode; and Parallel-Mono mode provides a single channel with double the output current of Stereo mode. These modes can be selected using the stereo/mono switch on the back panel. Each mode is wired differently, so be sure to note any special wiring requirements for the mode you will be using.

**3.3.1 Stereo (Two-Channel) Operation**

Stereo mode installation is very intuitive: input channel 1 feeds output channel 1, and input channel 2 feeds output channel 2. To put the amplifier into Stereo

mode, turn it off, slide the stereo/mono switch to the center position, and properly connect the output wiring as shown in Figure 3.5. Each output channel has two sets of binding posts to make it easier for you to connect multiple loudspeaker cables to each channel. Be sure to observe correct loudspeaker polarity (see Figure 3.5) and be careful not to short the outputs.

**CAUTION:** In Stereo mode, never tie an amplifier's outputs together directly, and never parallel them with the output of another amplifier. Such connections do not result in increased output power, but may activate the protection circuitry to prevent overheating.

**3.3.2 Bridge-Mono Operation**

Bridge-Mono mode is used to drive loads with a total impedance of at least 4 ohms (see Parallel-Mono if the load is less than 4 ohms). Wiring for Bridge-Mono mode is different from the other modes and requires special attention. First, turn off the amplifier. Then select Bridge-Mono mode by sliding the stereo/mono switch to the right (as you face the back panel). Both outputs receive the channel 1 input signal, but channel 2 is inverted so it can be bridged with channel 1. Do not use the channel 2 input or signal quality will be

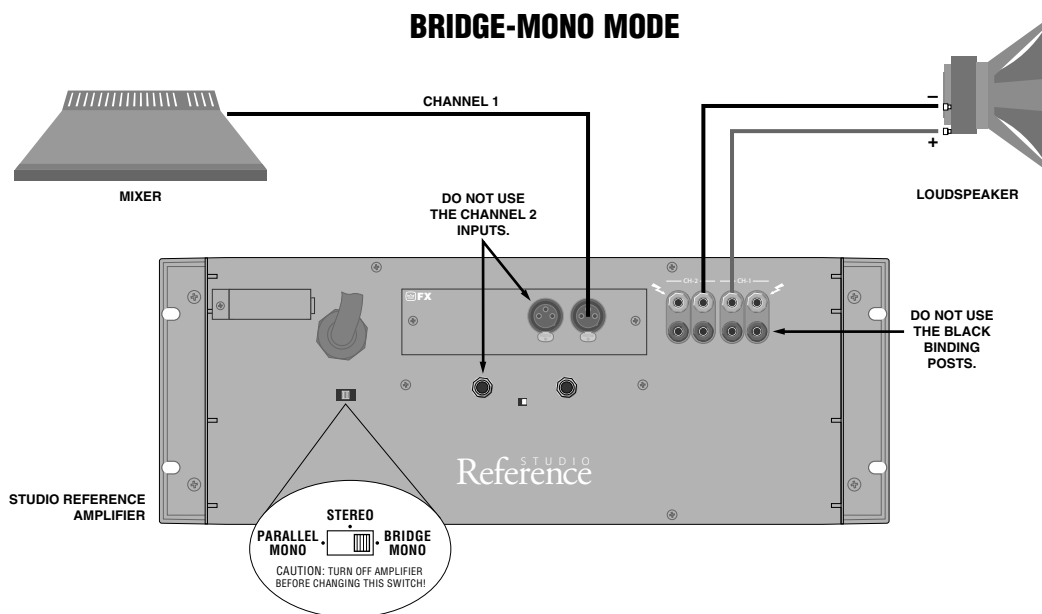

Fig. 3.6 Bridge-Mono Wiring

greatly degraded. Also, turn down the channel 2 level control (fully counterclockwise).

*Note: The channel 2 input and level control are not defeated in Bridge-Mono mode. Any signal feeding channel 2 will work against the channel 1 signal, and usually results in distortion and inefficient operation.*

Connect the load across the two red (+) binding posts (see Figure 3.6). The positive (+) loudspeaker lead connects to the red channel 1 binding post, and the negative (-) or ground lead from the loudspeaker connects to the red channel 2 binding post. Do not connect the black binding posts (-). Also, the load must be balanced (neither side shorted to ground).

**CAUTION: Only connect balanced equipment (meters, switches, etc.) to the Bridge-Mono output. Both sides of the line must be isolated from the input grounds or oscillations may occur.**

### 3.3.3 Parallel-Mono Operation

Parallel-Mono mode is used to drive loads with a total impedance of less than 4 ohms (see Bridge-Mono if the load is 4 ohms or more). Wiring for Parallel-Mono mode

is very different from the other modes and requires special attention.

To select Parallel-Mono mode, turn off the amplifier and slide the stereo/mono switch to the left (as you face the back panel). Connect the input signal to channel 1 only. The channel 2 input and level control are bypassed in this mode, so they should not be used.

*Note: It is normal for the channel 2 IOC indicator to stay on in Parallel-Mono mode.*

Connect the load to the channel 1 output as shown in Figure 3.7. The positive (+) lead from the loudspeaker connects to the red channel 1 binding post, and the negative (-) or ground lead from the loudspeaker connects to the black channel 1 binding post. Finally, install a jumper wire of at least 14 gauge between the channel 1 and channel 2 red binding posts.

**CAUTION: When Parallel-Mono wiring is installed, do not attempt to operate in Stereo or Bridge-Mono mode until the wiring is removed (especially the jumper wire). Failure to do so will result in high distortion and excessive heating.**

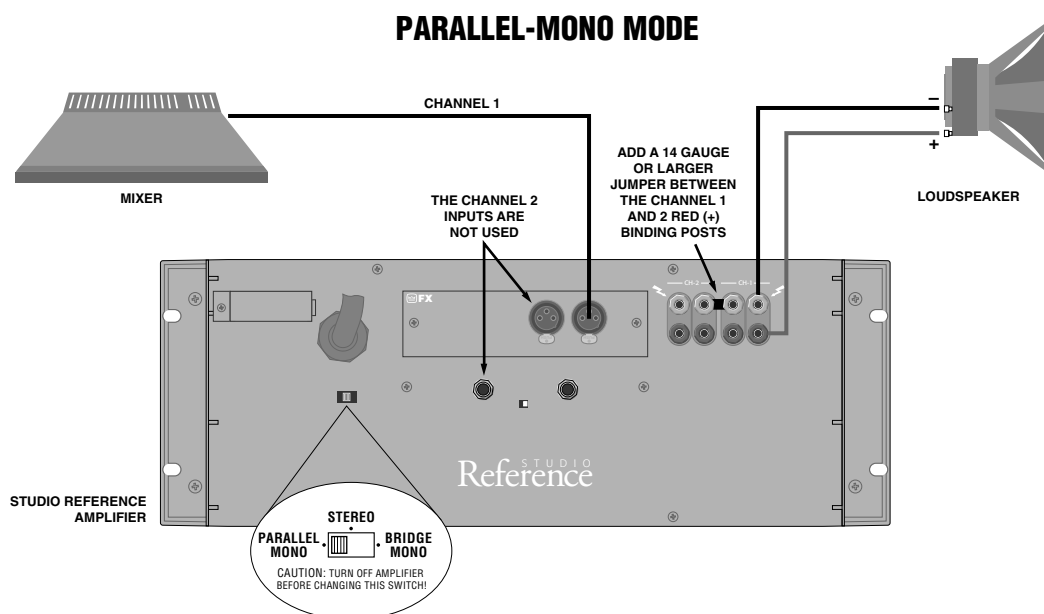

Fig. 3.7 Parallel-Mono Wiring

### 3.3.4 Input Connection

The balanced inputs have a nominal impedance of 10 K ohms (5 K ohms unbalanced) and will accept the line-level output of most devices. Phone jacks are provided on the back panel, while the factory-installed P.I.P.-FX provides female XLR input connectors (see Figure 2.2). Optional P.I.P. modules like the P.I.P.-BB and the P.I.P.-FPX can provide barrier block and phono (RCA) connectors. Various P.I.P.s are also available which provide a wide range of input signal processing features (see Section 8).

Correct input wiring depends on two factors: (1) whether the input signal is balanced or unbalanced, and (2) whether the signal floats or has a ground reference. Figures 3.8 and 3.9 show the recommended connection techniques for each combination of source signal characteristics.

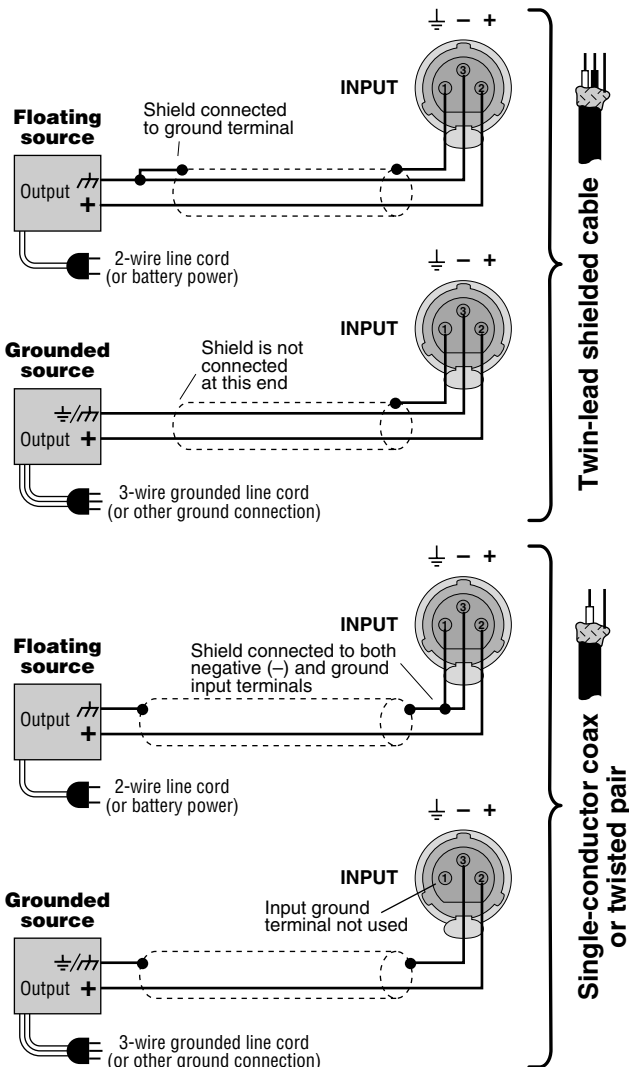

Fig. 3.8 Unbalanced Input Wiring

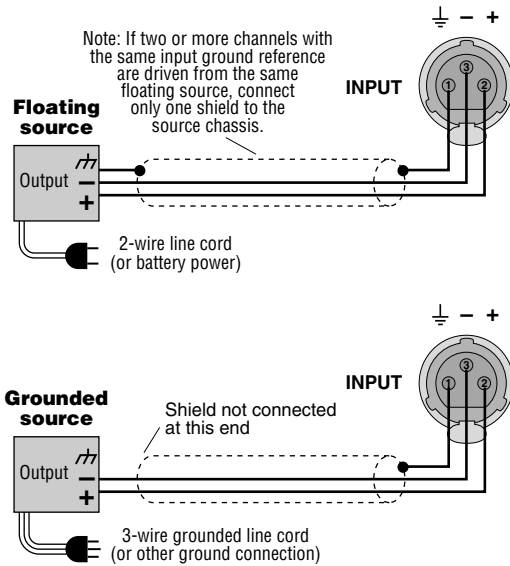

Fig. 3.9 Balanced Input Wiring

The amplifier's built-in 1/4-inch input phone jacks can be wired similarly for balanced or unbalanced, floating or ground-referenced sources. They have a standard tip-ring-sleeve (TRS) configuration: the tip is positive (+), the ring is negative (-) and the sleeve is ground (see Figure 3.10). Wiring for various sources follows the XLR wiring examples in Figures 3.8 and 3.9.

If you install a P.I.P. module other than the P.I.P.-FX, P.I.P.-BB, P.I.P.-FMX or P.I.P.-FPX, do not connect in-put signals to the phone jacks. The phone jacks are in parallel with the output of the P.I.P. module, so the source connected to the phone jacks can feed into the P.I.P. and generate a distortion in the output. The phone jacks can still be used as "daisy chain" outputs to feed the post-processed signal from the P.I.P. to the input of other amplifiers.

If the amplifier will be used in Bridge-Mono or Parallel-Mono mode, be sure to follow the instructions provided in Sections 3.3.2 and 3.3.3. Do not use the channel 2 input in either mono mode.

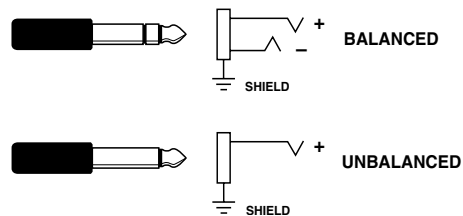

Fig. 3.10 Balanced and Unbalanced Phone Plugs

### SOLVING INPUT PROBLEMS

Sometimes large **subsonic** (subaudible) **frequencies** are present in the input signal. These can damage loudspeakers by overloading or overheating them. To attenuate such frequencies, place a capacitor in series with the input signal line. The graph in Figure 3.11 shows some capacitor values and how they affect the frequency response of a *Studio Reference* amplifier. Use only low-leakage capacitors.

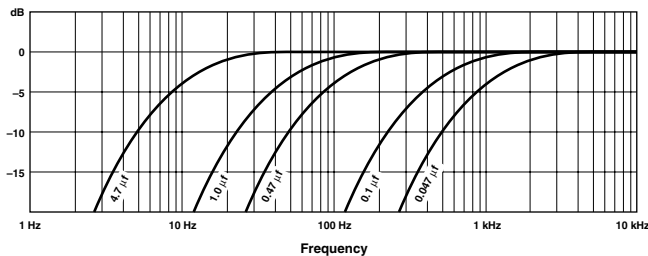
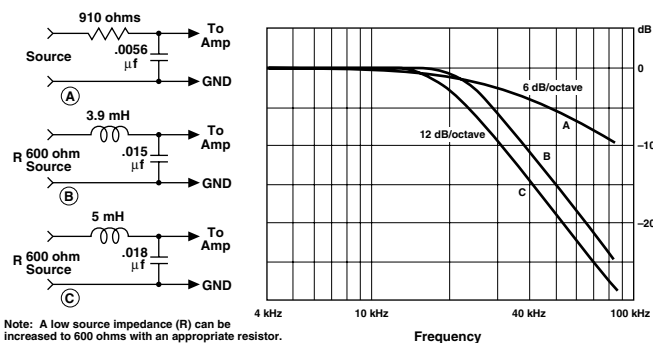

Fig. 3.11 Subsonic Filter Capacitors

Another problem to avoid is large levels of **radio frequencies** or RF in the input signal. Although high RF levels may not pose a threat to the amplifier, they can burn out tweeters or other loads that are sensitive to high frequencies. Extremely high RF levels can also cause your amplifier to prematurely activate its protection circuitry, resulting in inefficient operation. RF can be introduced into a signal by local radio stations and from the bias signal of many tape recorders. To prevent high levels of input RF, install an appropriate low-pass filter in series with the input signal. Some examples of unbalanced wiring for low-pass filters are shown in Figure 3.12.



Note: A low source impedance (R) can be increased to 600 ohms with an appropriate resistor.

Fig. 3.12 Unbalanced RF Filters

For balanced input wiring, use an example from Figure 3.13. Filters A, B and C correspond to the unbalanced filters shown in Figure 3.12. Filter D also incorporates the subsonic filter in Figure 3.11.

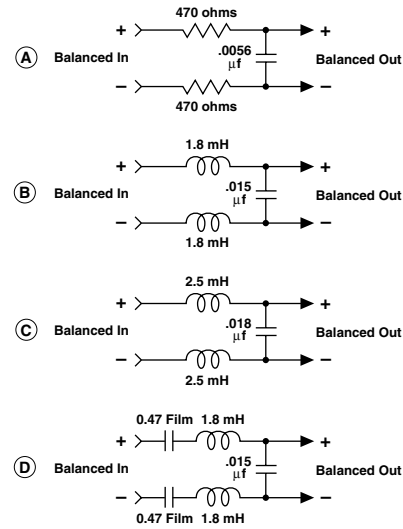

Fig. 3.13 Balanced RF Filters

**Tip:** The P.I.P.-FX has plenty of space on its circuit board for the addition of input filter circuitry.

Another problem to avoid is **ground loops**. These are undesired currents that flow in a grounded system and usually cause hum in the output. A common source of ground loop problems is the placement of input cables parallel to power cables or near power transformers. The magnetic field that surrounds these conductors can induce the 50 or 60 Hz alternating current into your input cables. To prevent this type of ground loop, it is always a good idea to locate input cables away from

### Input Wiring Tips

1. Use only shielded cable. Cables with higher density shields are better. Spiral wrapped shield is not recommended.
2. When using unbalanced lines, keep the cables as short as possible. Avoid cable lengths greater than 10 feet (3 meters).
3. Do not run signal cables together with high-level wiring such as loudspeaker wires or AC cords. This reduces the chance of hum or noise being induced into the input cables.
4. Turn the entire system off before changing connections. Turn level controls down before powering the system back up. Crown is not liable for damage incurred when any transducer or component is overdriven.

power cables and power transformers. We also recommend using shielded or twisted pair wire. With loose wires, use tie-wraps to bundle together each pair of input wires. This helps reduce magnetically-induced current by minimizing the cross-sectional area between conductors that could bisect the magnetic field.

Ground loops often occur when the input and output grounds are tied together. **DO NOT CONNECT THE INPUT AND OUTPUT GROUNDS TOGETHER.** Tying the grounds together can also cause **feedback oscillation** from the load current flowing in the loop. To avoid this problem, use proper grounding, isolate the inputs, and isolate other common AC devices. When using the input phone jacks, the signal grounds can be isolated from the AC mains ground with the ground lift switch located on the amplifier's back panel (see Figure 2.2 and Section 4.4).

### 3.3.5 Output Connection

Consider the rated power-handling capacity of your load before connecting it to the amplifier. Crown is not liable for damage incurred at any time due to overpowering. Fusing loudspeaker lines is highly recommended (see Section 3.3.6). Also, please pay close attention to Section 4.1, *Precautions*.

You should always install loudspeaker cables of sufficient gauge (wire thickness) for the length used. The resistance introduced by inadequate output wiring will reduce the amplifier's power to and motion control of the loudspeakers. The latter problem occurs because

the damping factor decreases as the cable resistance increases. This is very important because the amplifier's excellent damping factor can be easily negated by using insufficient cable.

Use the nomograph in Figure 3.14 and the procedure that follows to find the recommended wire gauge (AWG or American Wire Gauge) for your system.

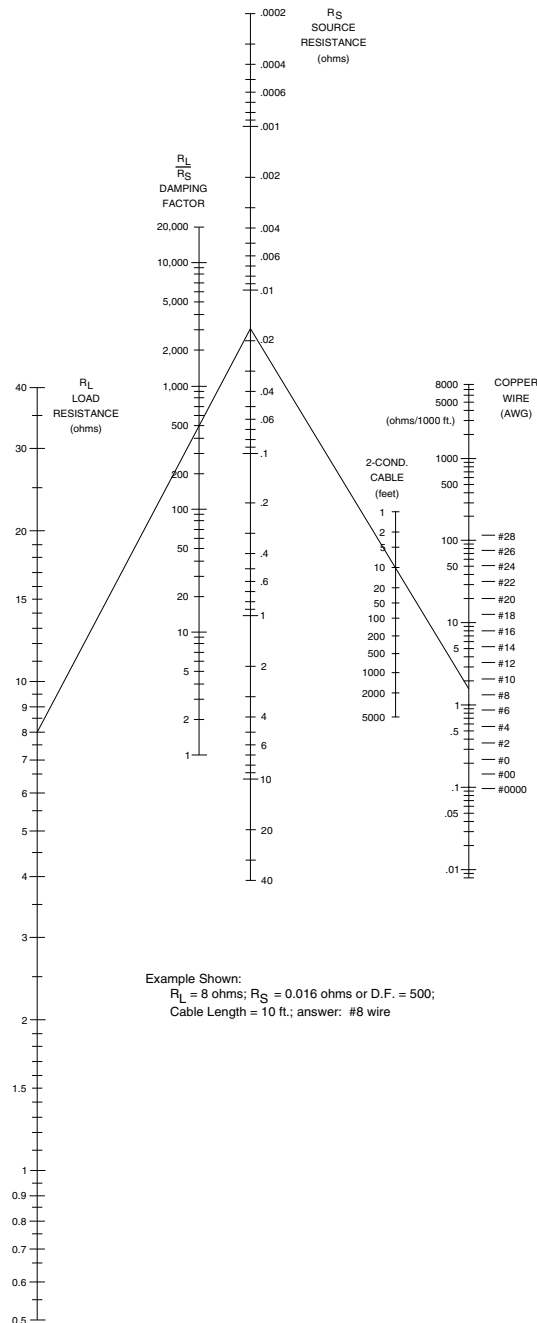

Fig. 3.14 Wire Size Nomograph

### Use Good Connectors

1. Male connectors on loudspeaker cables should not be exposed to prevent possible short circuits.
2. Connectors which might accidentally cause the two channels to be tied together when making and breaking connections should not be used. (A common example is the standard three-wire stereo phone plug.)
3. Connectors which can be plugged into AC power receptacles should never be used.
4. Connectors having low current-carrying capacity should not be used.
5. Connectors having any tendency to short should never be used.



1. For loads connected in parallel, use the equation that follows to calculate each channel's total load resistance. Substitute the rated impedance of the connected loudspeakers for the Zs in the equation. When finished, mark your answer on the nomograph's "Load Resistance" line.

$$\text{Total Load Resistance in Ohms} = (1/z_1 + 1/z_2 + 1/z_3 \dots)^{-1}$$

2. Select an acceptable damping factor and mark it on the "Damping Factor" line. Your amplifier can provide an phenomenal damping factor of 20,000 from 10 to 200 Hz in Stereo mode with an 8 ohm load. In contrast, most other amplifiers have a damping factor rating of 200 or less. Higher damping factors yield lower distortion and greater motion control over the loudspeakers. To give you a basis for comparison, effective damping factors for commercial applications typically run between 50 and 100. Higher damping factors may be desirable for live sound, but long cable lengths often limit the highest damping factor that can be achieved practically. (Under these circumstances, Crown's *IQ System* is often used so amplifiers can be easily monitored and controlled when they are located very near the loudspeakers.) In recording studios and home hi-fi, a damping factor of 500 or more is very desirable.

3. Draw a line through the two points with a pencil, and continue until it intersects the "Source Resistance" line.

4. On the "2-Cond. Cable" line, mark the length of the cable run.

5. Draw a pencil line from the mark on the "Source Resistance" line through the mark on the "2-Cond. Cable" line, and on to intersect the "Annealed Copper Wire" line.

6. The required wire gauge for the selected wire length and damping factor is the value on the "Annealed Copper Wire" line. *Note: Wire size increases as the AWG gets smaller.*

7. If the size of the cable exceeds what you want to use, (1) find a way to use shorter cables, like using the *IQ System*, (2) settle for a lower damping factor, or (3) use more than one cable for each line. Options 1 and 2 will require the substitution of new values for cable length or damping factor in the nomograph. For option 3, estimate the effective wire gauge by subtracting 3 from the apparent wire gauge every time the number of conductors of equal gauge is doubled. So, if #10 wire is too large, two #13 wires can be substituted, or four #16 wires can be used for the same effect.

### SOLVING OUTPUT PROBLEMS

**High frequency oscillations** can cause your amplifier to prematurely activate its protection circuitry. The effects of this problem are similar to the effects of the RF problem described in Section 3.3.4. To prevent high-frequency oscillations, follow these guidelines:

1. When using long cable runs, or when different

amplifiers share a common cable tray or jacket, use tie-wraps to bundle individual conductors so the wires for each loudspeaker are kept close together. (Do not bundle wires from different amplifiers.) This reduces the chance of conductors acting like antennas to transmit or receive the high frequencies that can cause oscillation.

2. Avoid using shielded loudspeaker cable.
3. Never tie together input and output grounds.
4. Never tie together the output of different amplifiers.
5. Keep output cables separated from input cables.
6. Install a low-pass filter in series with each input (see Section 3.3.4).
7. Install the input wiring according to the instructions in Section 3.3.4.

Another problem to avoid is the presence of large **subsonic currents** when primarily inductive loads are used. Examples of inductive loads are 70-volt step-up transformers and electrostatic loudspeakers.

Inductive loads can appear as a short circuit at low frequencies. This can cause the amplifier to produce large low-frequency currents and activate its protection circuitry. Always take the precaution of installing a high-pass filter in series with the amplifier's input when inductive loads are used. A three-pole, 18 dB per octave filter with a -3 dB frequency of 50 Hz is recommended (some applications may benefit from an even higher -3 dB frequency). Such a filter is described with the subsonic frequency problems in Section 3.3.4.

Another way to protect inductive loads from large low-frequency currents and prevent the amplifier from prematurely activating its protective systems is to parallel a 590 to 708  $\mu\text{F}$  nonpolarized motor start capacitor and 4-ohm, 20-watt resistor in series with the amplifier output and the positive (+) transformer lead. This circuit is shown in Figure 3.15. It uses components that are

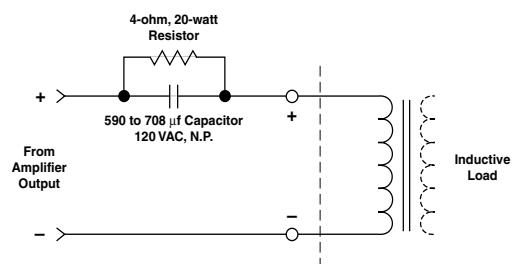

Fig. 3.15 Inductive Load (Transformer) Network

available from most electrical supply stores.

### 3.3.6 Additional Load Protection

*Studio Reference* amplifiers can deliver very high power levels, so it's a good idea to add protection for your loudspeakers if it is not built-in. Loudspeakers are subject to thermal damage from sustained overpowering and mechanical damage from large transient voltages. In both cases, fuses may be used to protect your loudspeakers, or you may opt for the convenience of a *P.I.P.* module that provides similar protection.

Thermal protection and voltage protection require different types of fuses. Slow-blow fuses are used to prevent thermal damage because they respond to thermal conditions like a loudspeaker. High-speed instrument fuses like the Littlefuse 361000 series are used to protect loudspeakers from transient voltages. The nomograph in Figure 3.16 can be used to select the correct fuse for thermal or voltage protection.

There are two common ways to install the fuses. One approach is to put a single fuse in series with each output. This is easy because there is only one fuse per channel to install. But if the fuse blows, power is removed to all of the connected loads.

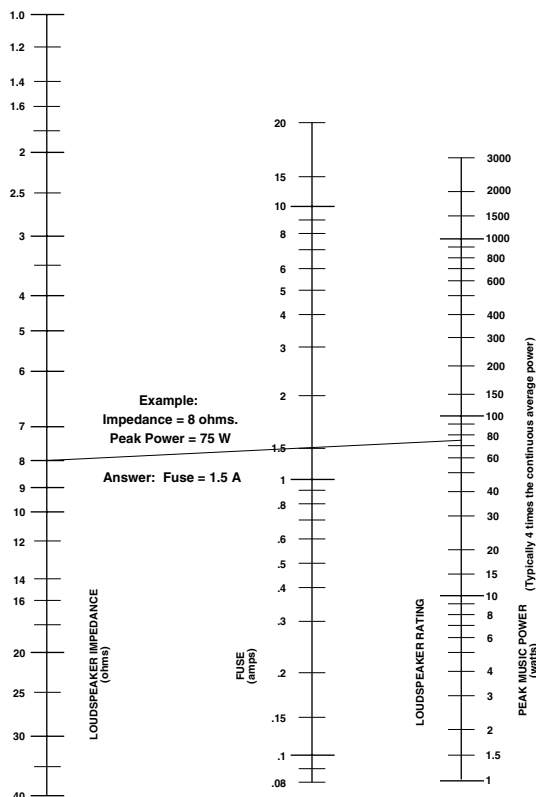

Fig. 3.16 Loudspeaker Fuse Nomograph

A better approach is to fuse each driver independently. This allows you to apply the most appropriate protection for the type of driver being used. In general, low-frequency drivers (woofers) are most susceptible to thermal damage and high-frequency drivers (tweeters) are usually damaged by large transient voltages. This means that your loudspeakers will tend to have better protection when the woofers are protected by slow-blow fuses and high-frequency drivers are protected by high-speed instrument fuses.

Depending on the application, you may want to use a specialized *P.I.P.* module to protect your loudspeakers. Again, some modules are more appropriate for long-term thermal protection, while others are more appropriate for protection against transients. A *Smart Amp™* IQ-P.I.P. module is most commonly used for long-term loudspeaker thermal protection. Each *Smart Amp* channel provides an independent “smooth output limiter” that controls average output levels over time while it allows transients to pass.

Most of the other *P.I.P.* modules that provide signal-driven compression can be used to prevent loudspeaker damage from transient voltage. These modules include the P.I.P.-AMCb, P.I.P.-EDCb and P.I.P.-PA. While the P.I.P.-EDCb is most commonly used for general loudspeaker protection, the P.I.P.-AMCb is very popular in systems that require a high-quality crossover, and the P.I.P.-PA is the processor of choice for applications that require a microphone and line level input for each channel. And finally, the *Smart Amp* IQ-P.I.P.-DP provides both an input compressor for transient protection and a smooth output limiter for long-term thermal protection. For more information on *P.I.P.* modules, see Section 8.

### 3.4 AC Mains Power

All *Studio Reference* amplifiers are shipped with an appropriate line cord and plug. The 120 VAC, 60 Hz North American *Studio Reference I* has a special TT30P plug and includes a matching receptacle. Always use an isolated power receptacle whenever possible with adequate voltage and current. Excessive line voltages 10% or higher above the rated voltage will cause the amplifier to activate its standby mode (see Section 4.3.2). For example, do not exceed a 132 VAC with models rated for 120 VAC operation.

Unless otherwise noted, all specifications in this manual were measured using 120 VAC, 60 Hz power mains with voltage accurate to within 0.5% and THD of less than 1.0% under all test conditions. Performance variations can occur at other AC mains voltages and line frequencies. Line regulation problems will directly affect the output power available from the amplifier.

## 4 Operation

### 4.1 Precautions

Although your amplifier is protected from internal and external faults, you should still take the following precautions for optimum performance and safety:

1. Improper wiring for the Stereo, Bridge-Mono or Parallel-Mono modes can result in serious operating difficulties (see Sections 3.3.1 through 3.3.3).
2. When driving an inductive load like an electrostatic loudspeaker, use a high-pass filter or protective network to prevent premature activation of the amplifier's protection circuitry (see Section 3.3.4).



3. **WARNING:** Do not change the position of the stereo/mono switch unless the amplifier is first turned off.



4. **CAUTION:** In Parallel-Mono mode, a jumper must be installed between the channel 1 and 2 red (+) binding post outputs. Be sure to remove this jumper for Stereo or Bridge-Mono modes, otherwise high distortion and excessive heating will occur. Check the stereo/mono switch on the back panel for proper position.



5. Turn off the amplifier and unplug it from the AC mains before removing the amplifier's *P.I.P.* module or dust filter.

6. Use care when making connections, selecting signal sources and controlling the output level. The load you save may be your own!

7. Do not short the ground lead of an output cable to the input signal ground. This will form a ground loop and may cause oscillations.

8. Operate the amplifier from AC mains of not more than 10% above or below the selected line voltage and only at the rated line frequencies.



9. Never connect the output to a power supply output, battery or power main. Such connections may result in electrical shock.

10. Tampering with the circuitry by unqualified personnel, or making unauthorized circuit changes may be hazardous and invalidates all agency listings.

*Remember: Crown is not liable for damage that results from overdriving other system components.*

### 4.2 Indicators

The front panel has several helpful indicators. The **enable indicator** is provided to show the amplifier has been turned on (or enabled) and that its low-voltage



Fig. 4.1 Indicators

power supply and on-demand forced air cooling system are working. It does not indicate the status of the high-voltage power supplies. For example, the enable indicator will stay on in the improbable event that one or both channels overheat causing an internal shut down of the high voltage supplies.

The green **ODEP indicators** confirm the normal operation of Crown's patented Output Device Emulation Protection circuitry. During normal operation, they glow brightly to confirm the presence of reserve thermodynamic energy. They dim proportionally as the energy reserve decreases. In the rare event that there is no reserve, the indicators will turn off and *ODEP* will proportionally limit the drive level of the output stages so the amplifier can continue safe operation even when the operating conditions are severe. (For a more detailed description of *ODEP*, see Section 4.3.1.)

A channel's *ODEP* indicator also turns off if its high-voltage power supply is put in "standby" mode or the amplifier's circuit breaker is tripped. The standby mode is activated if DC or heavy common-mode current is detected in the output, if the transformer thermal protection system is activated, if a *P.I.P.* like the *Smart Amp IQ-P.I.P.* is used to shut down a high-voltage supply, or if excessive AC mains voltage is detected. For more information see Section 4.3 and the table in Figure 4.2.

The yellow **IOC indicators** act as sensitive distortion meters to provide *proof of distortion-free performance*. The *IOC* (Input/Output Comparator) circuitry compares the incoming signal's waveform to that of the output. Any difference between the two is distortion. The *IOC* indicators flash if there is a difference of 0.05% or more. The *IOC* indicators also show input overload by flashing brightly with a half-second hold delay. It is normal for them to light momentarily when the amplifier is first turned on. *Note: The channel 2 IOC indicator will stay on in Parallel-Mono mode. Also, an IOC indicator will stay on in abnormal situations where a high-voltage power supply is temporarily put in standby mode.*

The green **signal presence indicators** flash synchronously with the amplifier's output signal. The signal detector is connected to the signal path after the input gain stages and level controls, so a flashing indicator tells you that there is audio in and out of the amplifier. *Note: The signal presence indicators may not report signal presence if the output signal level is too low.*

The **dynamic range/level meters** are five-segment output meters that can be set to monitor either the dynamic range or the level of the output signal. They are factory-set to show dynamic range. A switch located behind the front panel is used to select the meter display mode (see Section 4.4 for complete instructions).

As dynamic range meters they show each channel's ratio of peak-to-average power in dB. The dynamic range may be low for sources like AM/FM radio or low-quality recordings. Other sources like live music or high-quality recordings may be much higher. As output level meters they show how high the output levels are in dB relative to full power. At 0 dB, the unit is delivering full standard 1 kHz power (see Section 6).

### 4.3 Protection Systems

Studio Reference amplifiers provide extensive protection and diagnostics capabilities. Protection systems include *ODEP*, standby mode, an AC circuit breaker









Indicator Status	Amplifier Condition
<p><b>ODEP IOC SIGNAL</b></p> <p></p> <p>OFF OFF OFF</p>	<p><b>There is no power to the amplifier.</b> Possible reasons: (1) The amplifier's enable switch is off. (2) The amplifier is not plugged into the power receptacle. (3) The AC mains circuit breaker has been tripped. (4) The amplifier's circuit breaker has been tripped.</p>
<p><b>ODEP IOC SIGNAL</b></p> <p></p> <p>ON OFF OFF</p>	<p><b>Normal operation for a channel with NO output.</b> Possible reasons: (1) There is no input signal. (2) The input signal level is very low. (3) The channel's level control is turned down.</p>
<p><b>ODEP IOC SIGNAL</b></p> <p></p> <p>OFF ON OFF</p>	<p><b>The amplifier is in standby mode.</b> Possible reasons: (1) The amplifier has just been turned on and is still in the four second turn-on delay. (2) A <i>P.I.P.</i> module such as an IQ-P.I.P. has turned off the channel's high-voltage supply. (3) The DC/low-frequency protection circuitry has been activated. (4) The fault protection circuitry has been activated. (5) The transformer thermal protection circuitry has been activated. (6) The overvoltage protection circuitry has been activated.</p>
<p><b>ODEP IOC SIGNAL</b></p> <p></p> <p>OFF OFF Active</p>	<p><b>ODEP limiting is about to begin or has just ended.</b> Possible reasons: (1) The amplifier's air filter is blocked and needs to be cleaned. (2) There is insufficient cooling because of inadequate air flow or air that is too hot. (3) The load impedance for the channel is too low because the output is shorted or the amplifier is driving too many loudspeakers for the selected stereo/mono mode. (4) The amplifier channel is continuously being driven to very high output levels.</p>
<p><b>ODEP IOC SIGNAL</b></p> <p></p> <p>ON ON OFF</p>	<p><b>Channel 2 only: The amplifier is in Parallel-Mono mode with no output.</b> The channel 2 <i>IOC</i> indicator always turns on when the amplifier's stereo/mono switch is moved to the Parallel-Mono position.</p>
<p><b>ODEP IOC SIGNAL</b></p> <p></p> <p>ON OFF Active</p>	<p><b>Normal operation for a channel with audio output.</b> The <i>ODEP</i> indicator will remain at full intensity to show that there is reserve thermal-dynamic energy and the signal presence indicator will flash to show that there is audio output.</p>
<p><b>ODEP IOC SIGNAL</b></p> <p></p> <p>OFF ON Active</p>	<p><b>ODEP limiting has been activated.</b> Possible reasons: (1) The amplifier's air filter is blocked and needs to be cleaned. (2) There is insufficient cooling because of inadequate air flow or air that is too hot. (3) The load impedance for the channel is too low because the output is shorted or the amplifier is driving too many loudspeakers for the selected stereo/mono mode. (4) The amplifier channel is continuously being driven to very high output levels.</p>
<p><b>ODEP IOC SIGNAL</b></p> <p></p> <p>ON ON Active</p>	<p><b>The channel's output is exceeding 0.05% distortion.</b> The input signal level is too high, and <i>IOC</i> is reporting either an input overload or output clipping.</p> <p style="text-align: center;">OR</p> <p><b>Channel 2 only: The amplifier is in Parallel-Mono mode and has output.</b> The channel 2 <i>IOC</i> indicator always turns on when the amplifier's stereo/mono switch is moved to the Parallel-Mono position.</p>

Fig. 4.2 Studio Reference Indicator States

and transformer thermal protection. These systems will prevent amplifier damage in virtually any situation.

#### 4.3.1 ODEP

Crown invented *ODEP* to solve two long-standing problems in amplifier design: to prevent amplifier shut-down during demanding operation and to increase the efficiency of output circuitry.

To do this, Crown established a rigorous program to measure the *safe operating area* (SOA) of each output transistor before installing it in an amplifier. Next, Crown designed intelligent circuitry to simulate the instantaneous operating conditions of the output transistors. Its name describes what it does: Output Device Emulation Protection or *ODEP*. In addition to simulating the operating conditions of the output transistors, it also compares their operation to their known SOA. If *ODEP* sees that more power is about to be asked of the output transistors than they are capable of delivering under the present conditions, *ODEP* immediately limits the drive level until it falls within the SOA. Limiting is proportional and kept to an absolute minimum—only what is required to prevent output transistor damage.

This level of protection enables Crown to increase output efficiency to never-before-achieved levels while greatly increasing amplifier reliability.

The on-board intelligence is monitored two ways. First, the amplifier's *ODEP* indicators show whether the unit is functioning correctly or if *ODEP* is limiting output. Second, *ODEP* data is fed to the amplifier's internal *P.I.P.* connector so advanced *P.I.P.* modules like the IQ-P.I.P. can use it to monitor and control the amplifier.

This is how *ODEP* keeps the show going with maximum power and maximum protection at all times.

#### 4.3.2 Standby Mode

An important part of a *Studio Reference* amplifier's protection systems is standby mode. Standby protects the amplifier during potentially catastrophic conditions. It temporarily removes power from the high-voltage supplies to protect the amplifier and its loads. Standby mode can be identified using the table in Figure 4.2.

Standby mode is activated in five situations. First, when you turn on the enable switch, standby mode is activated to provide **turn-on protection**. This power-up delay lets other system components settle before any signals are amplified and it provides some power-up "randomness" for multiple units so the system's start-up current demands are better distributed over time.

The amplifier's **overvoltage protection** circuitry will put both channels into standby when excessive AC mains voltage is detected. *Studio Reference* amplifiers should not be operated with an AC mains voltage of more than 10% over the unit's rated voltage.

If dangerous subsonic frequencies or direct current (DC) is detected in the amplifier's output, the unit will activate its **DC/low-frequency protection** circuitry and put the affected channels in standby. This protects the loads and prevents oscillations. The amplifier resumes normal operation as soon as it no longer detects dangerous low-frequency or DC output. Although it is extremely unlikely that you will ever activate the amplifier's DC/low-frequency protection system, improper source materials such as subsonic square waves or input overloads that result in excessively clipped signals can activate this system.

The amplifier's **fault protection** system will put an amplifier channel into standby mode in rare situations where heavy common-mode current is detected in the channel's output. The amplifier should never output heavy common-mode current unless its circuitry is damaged in some way, and putting the channel into standby mode helps to prevent further damage.

The amplifier's **transformer thermal protection** circuitry is activated in very unusual circumstances where the unit's transformer temperature rises to unsafe levels. Under these abnormal conditions, the amplifier will put both channels into standby mode. The amplifier will return to normal operation after the transformer cools to a safe temperature. (For more information on transformer thermal protection, refer to the section that follows.)

#### 4.3.3 Transformer Thermal Protection

All *Studio Reference* amplifiers have transformer thermal protection which protects the power supplies from damage under rare conditions where the transformer temperature rises too high. A thermal switch embedded in the transformer removes power to the high-voltage power supplies if it detects excessive heat. The switch automatically resets itself as soon as the transformer cools to a safe temperature.

If your amplifier is operated within rated conditions, it is extremely unlikely that you will ever see it activate transformer thermal protection. One reason is that *ODEP* keeps the amplifier working under very severe conditions. Even so, higher than rated output levels, excessively low-impedance loads and unreasonably high input signals can generate more heat in the trans-

former than in the output devices. This can overheat the transformer and activate its protection system.

*Studio Reference* amplifiers are designed to keep working under conditions where other amplifiers would fail. But even when the limits of a *Studio Reference* amplifier are exceeded, it still protects itself—and your investment—from damage.

#### 4.3.4 Circuit Breaker

A back panel circuit breaker is provided to prevent excessive current draw by the high-voltage power supplies. A *Studio Reference I* configured for 100 to 120 VAC has a 30 amp circuit breaker, while the 220 to 240 VAC version has a 20 amp circuit breaker. A *Studio Reference II* configured for 100 to 120 VAC uses a 20 amp circuit breaker, and the 220 to 240 VAC version has a 10 amp circuit breaker. With rated loads and output levels, this breaker should only trip in the incredibly rare instance of a catastrophic amplifier failure. The *ODEP* system keeps the amplifier safe and operational under most other severe conditions. The breaker can also trip in situations where extremely low-impedance loads and high output levels result in current draw that exceeds the breaker's rating. Again, this should only be possible when operating *outside rated conditions*, like when the amplifier is used to drive a 1 ohm load, or when an input signal is clipped severely.

#### 4.4 Controls

The front panel **enable switch** is used to turn the amplifier on and off. If you ever need to make any wiring or installation changes, don't forget to disconnect the power cord first. Please follow these steps when first turning on your amplifier:

1. Turn down the level of your audio source. For example, set your mixer's volume to  $-\square$  (off).
2. Turn down the amplifier's level controls.
3. Turn on the enable switch. The enable indicator beside the switch should glow. During the four second turn-on delay that immediately follows, the indicators will flash as described in Figure 4.2. After the delay, the *ODEP* indicators should come on with full brilliance and the *IOC* and signal presence indicators should function normally.
4. After the turn-on delay, turn up your source to the maximum desired level.
5. Turn up the amplifier's level controls until the maximum desired sound level is achieved.
6. Turn down the level of your audio source to its normal range.

Each of the front panel **level controls** has 31 detents for accurately repeatable settings. In Bridge-Mono and Parallel-Mono modes, the channel 2 level control should be turned down.

The **meter switches** are located behind the front panel. They make it possible to switch between the dynamic range and signal level display modes for the meters, or you can turn the meters off. From the factory, the meters automatically display dynamic range (which is computed as the ratio of peak to average output power). To change these switches, you will need to remove part of the front panel. A phillips screwdriver will be needed, and it will help to remove the amplifier if it is mounted in a rack. Follow these steps:

1. Make sure the amplifier is turned off and its power cord is disconnected from the AC mains source.
2. Remove the two screws that hold each end cap in place and remove both end caps (see Figure 3.2).
3. Remove the six screws that hold each handle in place and remove each handle (see Figure 4.3).
4. Remove the dust filter by gently pulling it away from the front panel.
5. Remove the two screws that secure the lower half of the front panel and remove the lower front panel.
6. Locate the meter switches as shown in Figure 4.4. Set the switches as desired. The left switch is used to turn the meters on and off, and the right switch is used to change display modes.
7. Reassemble the front panel, handles and end caps in reverse order of disassembly.
8. Install the amplifier and reconnect power.

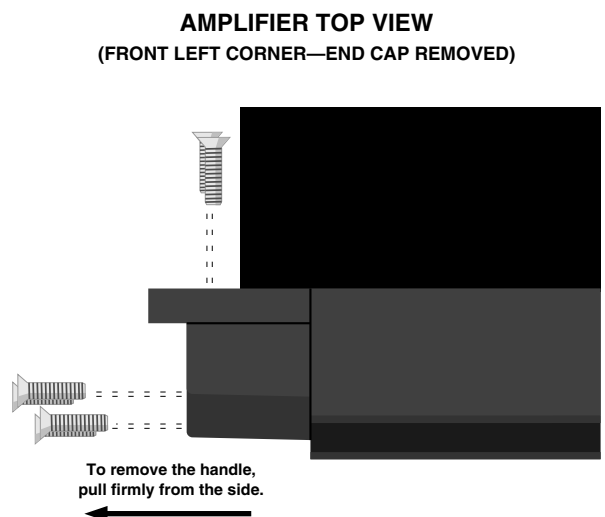

Fig. 4.3 Removing a Handle

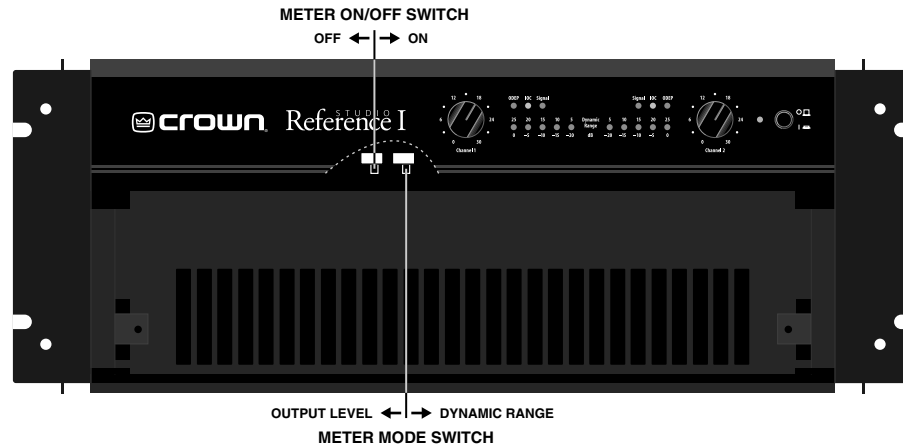

Fig. 4.4 Meter Switches

The **input sensitivity switch** is located inside the amplifier's *P.I.P.* compartment. It is factory-set to a fixed voltage gain of 26 dB. For standard 1 kHz power into 8 ohms, this is equivalent to an input sensitivity of 4.0 volts for the *Studio Reference I* and 2.7 volts for the *Studio Reference II*. If needed, it can be switched to a sensitivity of 0.775 or 1.4 volts. Here is the procedure:

1. Turn off the amplifier and disconnect the power cord from the receptacle.
2. Remove the *P.I.P.* module.
3. Locate the access hole for the sensitivity switch inside the chassis opening (see Figure 4.5).
4. Set the switch to the desired position noted on the access hole label.
5. Replace the *P.I.P.* module and restore power.

The **ground lift switch** located on the back panel can provide isolation between the phone jack input grounds and the AC (chassis) ground. It does not affect the *P.I.P.* module's input connectors. Slide the

switch to the left to isolate or "lift" the grounds.

*Note: The noninverted and inverted signal lines for the P.I.P. module are connected in parallel with the corresponding lines of the phone jack inputs. The input signal grounds are not paralleled. Specifically, XLR pins 2 and 3 are connected in parallel with the tip and ring of the corresponding phone jack. However, pin 1 of the XLR is not connected in parallel with the sleeve of the phone jack. This makes it possible for a P.I.P. module to handle its own signal grounds independently.*

The amplifier's circuit breaker protects the power supplies from overload. The breaker's **reset switch** is located on the back panel. Facing the back panel, move the reset switch the left to disconnect power to the power supplies, or to the right to reconnect power. If the circuit breaker trips, the front panel enable indicator will turn off. If this occurs, turn off the enable switch, flip the reset switch to the right (on), and then turn the enable switch back on. If it trips again or the amplifier does not operate properly, contact an authorized service center or Crown's Technical Support Group.

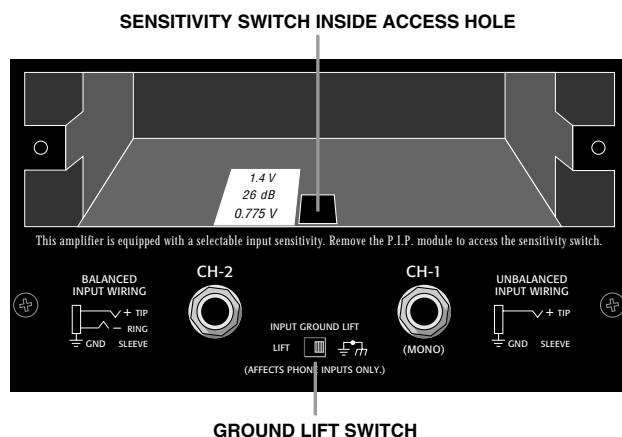

Fig. 4.5 Input Sensitivity and Ground Lift Switches

### 4.5 Filter Cleaning

A dust filter is provided on the amplifier's air intake (see Figure 2.1). If this filter becomes clogged, the unit will not cool as efficiently as it should and high heat sink temperatures may produce lower-than-normal output.

To clean the filter, gently pull it away from the front panel and wash it with mild dishwashing detergent and warm water. Be sure the filter is dry before you reinstall it. Replacement filters may be ordered from the factory.

Dust filters are not 100% efficient—long term this may require heat sink cleaning by a qualified technician. Internal cleaning information is available from our Technical Support Group.

## 5 Technical Information

### 5.1 Overview

*Studio Reference* amplifiers incorporate several new technological advancements including real-time computer simulation of output transistor stress, low-stress output stages, an advanced heat sink embodiment and the Programmable Input Processor (*P.I.P.*) expansion system.

Custom circuitry is incorporated to limit temperature and current to safe levels making it highly reliable and tolerant of faults. Unlike many lesser amplifiers, it can operate at its voltage and current limits without self-destructing.

*Studio Reference* amplifiers are protected against all common hazards that plague high-power amplifiers including shorted, open or mismatched loads; overloaded power supplies, excessive temperature, chain-destruction phenomena, input overload and high-frequency blowups. The unit protects loudspeakers from input and output DC, as well as turn-on and turn-off transients.

Real-time computer simulation is used to create an analogue of the junction temperature of the output transistors (hereafter referred to as the output devices). Current is limited only when the device temperature becomes excessive—and only by the minimum amount necessary. This patented approach maximizes the available output power and eliminates overheating—the major cause of device failure.

Crown also invented the four-quadrant topology used in the output stages of each *Studio Reference* amplifier (see Figure 5.1). This special circuitry is called the *grounded bridge*. It makes full use of the power supply by delivering peak-to-peak voltages to the load that are twice the voltage seen by the output devices.

As its name suggests, the *grounded bridge* topology is referenced to ground. Composite devices are constructed to function as gigantic NPN and PNP devices to handle currents which exceed the limits of available devices. Each output stage has two composite NPN and two composite PNP devices.

The devices connected to the load are referred to as “high-side NPN and PNP” and the devices connected to ground are referred to as “low-side NPN and PNP.” Positive current is delivered to the load by increasing conductance simultaneously in the high-side NPN and low-side PNP stage, while synchronously decreasing conductance of the high-side PNP and low-side NPN.

The two channels may be used together to double the voltage (Bridge-Mono) or the current (Parallel-Mono) presented to the load. This feature gives you the flexibility to maximize power available to the load.

A wide bandwidth, multiloop design is used for state-of-the-art compensation. This produces ideal behavior and results in ultra-low distortion values.

Aluminum extrusions are used widely for heat sinks in power amplifiers due to their low cost and reasonable performance. However, measured on a watts per pound or watts per volume basis, the extrusion technology doesn't perform nearly as well as the heat sink technology developed for *Studio Reference* amplifiers.

Our heat sinks are fabricated from custom convoluted fin stock that provides an extremely high ratio of area to volume, or area to weight. All power devices are mounted directly to the heat sinks which are also electrically at the Vcc potential. Electrifying the heat sinks improves thermal performance by eliminating the insulating interface underneath the power devices. The chassis itself is even used as part of the thermal circuit to maximize utilization of the available cooling resources.

### 5.2 Circuit Theory

Power is provided by low-field toroidal power transformer T1. The secondaries of T1 are full-wave rectified (by D1 through D4, D22 and D24) and filtered by large computer grade capacitors. A thermal switch embedded in the transformer protects it from overheating. Monolithic regulators provide a regulated  $\pm 15$  volts.

#### 5.2.1 Stereo Operation

For simplicity, the discussion of Stereo operation will refer to only one channel. Mono operation will be discussed later. Please refer to the block diagram in Figure 5.1 and the schematics included with this manual.

The input signal at the phone jack passes directly into the balanced gain stage (U104-A). When a *P.I.P.* module is used, the input signal first passes through the *P.I.P.*'s circuitry and then to the balanced gain stage.

The balanced gain stage (U104-A) causes balanced to single-ended conversion using a difference amplifier. From there, gain can be controlled with the front panel level controls and the input sensitivity switch. The error amp (U104-C) amplifies the difference between the



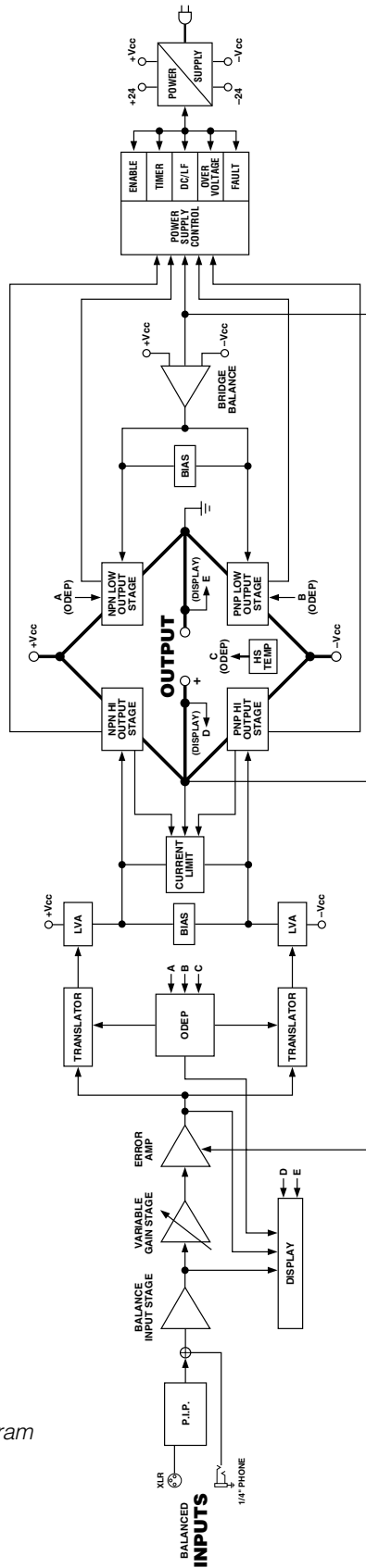

ONLY ONE CHANNEL SHOWN

Fig. 5.1 Circuit Block Diagram

output signal and the input signal from the gain pot, and drives the voltage-translator stage.

From the error amp, the voltage translator stage channels the signal to the Last Voltage Amplifiers (LVAs) depending on the signal polarity. The +LVA (Q104 and Q105) and the -LVA (Q110 and Q111) drive the fully complementary output stage with their push-pull effect through the bias servo Q318.

The bias servo Q318 is thermally coupled to the heat sink, and sets the quiescent bias current in the output stage to lower the distortion in the crossover region of the output signal.

With the voltage swing provided by the LVAs, the signal then gains current amplification through the triple Darlington emitter-follower output stage.

The bridge-balanced circuit (U104-D) receives a signal from the output of the amplifier, and differences it with the signal at the Vcc supply. The bridge-balanced circuit then develops a voltage to drive the bridge-balanced output stage. This results in the Vcc supply having exactly one half of the output voltage added to its quiescent voltage. Bias servo Q300 sets the quiescent current point for the bridge-balanced output stage.

The protection mechanisms that affect the signal path are implemented to protect the amplifier under real-world conditions. These conditions are high instantaneous current, excessive temperature, and output device operation outside safe conditions.

Q107 and Q108 act as a conventional current limiter, sensing current in the output stage. When output current at any instant exceeds the design criteria, the limiters remove drive from the LVAs, thus limiting current in the output stage to a safe level.

To further protect the output stages, the patented *ODEP* circuitry is used. It produces an analog output proportional to the always changing *safe operating area* of the output transistors. This output controls the translator stage previously mentioned, removing any further drive that may exceed the *safe operating area* of the output stage.

Thermal sensor S100 gives the *ODEP* circuit vital information on the operating temperature of the heat sink on which the output devices are mounted.

Should the amplifier fail in such a way that would cause

DC across the output leads, the DC/low-frequency protection circuit senses this on the negative feedback loop and shuts down the power supply until the DC is removed.

### 5.2.2 Bridge-Mono Operation

By setting the back panel stereo/mono switch to Bridge-Mono, the user can convert the amplifier into a bridged, single-channel amplifier. With a signal applied to the channel 1 input jack and the load connected across the two channels' red (+) 5-way binding posts, twice the voltage can be output.

The channel 1 output feeds the channel 2 error amp U204-C. Because there is a net inversion, channel 2 output is out of polarity with channel 1. This produces twice as much voltage across the load. Each channel's protection mechanisms work independently if a fault occurs.

### 5.2.3 Parallel-Mono Operation

With the stereo/mono switch set to Parallel-Mono, the output of channel 2 is paralleled with the output of channel 1. A suitable jumper capable of handling high current must be connected across the red (+) 5-way posts to gain the benefits of this mode of operation.

The signal path for channel 1 is the same as previously discussed, except channel 1 also drives the output stage of channel 2. The channel 2 balanced input, error amp, translators and LVAs are disconnected and no longer control the channel 2 output stage. Disconnecting the front-end stages from the channel 2 output causes the channel 2 *IOC* circuit to note that the input waveform (which is not present) does not match the output waveform (which is driven by the channel 1 input signal). This activates the channel 2 *IOC* indicator any time the amplifier is switched into Parallel-Mono mode. The channel 2 output stage and protection mechanisms are also coupled through S1 and function as one.

In Parallel-Mono mode, twice the current of one channel alone can be obtained. Because the channel 2 *ODEP* circuit is coupled through S1, this gives added protection if a fault occurs in the channel 2 output stage. The *ODEP* circuit of channel 2 will limit the output of both output stages by removing the drive from the channel 1 translator stages.

## 6 Specifications

The following applies to units in Stereo mode with 8 ohm loads and an input sensitivity of 26 dB gain unless otherwise specified.

**Low-Distortion 1 kHz Power:** refers to maximum average power in watts at 1 kHz with 0.02% THD and noise.

**Standard 1 kHz Power:** refers to maximum average power in watts at 1 kHz with 0.1% THD and noise.

**Full Bandwidth Power:** refers to maximum average power in watts from 20 Hz to 20 kHz with 0.1% THD and noise.

### Performance

**Frequency Response:**  $\pm 0.1$  dB 20 Hz to 20 kHz at 1 watt (see Figure 6.5).

**Phase Response:** +5 to -15 degrees from 20 Hz to 20 kHz at 1 watt (see Figure 6.8).

**Signal-to-Noise:** (A-weighted)

*Studio Reference I:* Greater than 120 dB below rated full bandwidth power.

*Studio Reference II:* Greater than 117 dB below rated full bandwidth power.

**Total Harmonic Distortion (THD):** Less than 0.02% at rated low-distortion 1 kHz power. Less than 0.1% at rated full bandwidth power.

**Intermodulation Distortion (IMD):** (60 Hz and 7 kHz 4:1)

*Studio Reference I:* Less than 0.005% from full bandwidth power to 78 watts rising linearly to 0.025% at 78 milliwatts.

*Studio Reference II:* Less than 0.005% from full bandwidth power to 36 watts rising linearly to 0.025% at 36 milliwatts.

**Damping Factor:** Greater than 20,000 from 10 Hz to 200 Hz, and greater than 2,500 at 1 kHz (see Figure 6.6).

**Crosstalk:** (At rated full bandwidth power)

*Studio Reference I:* Better than 100 dB from 20 Hz to 100 Hz falling linearly to better than 70 dB at 20 kHz (see Figure 6.10).

*Studio Reference II:* Better than 100 dB from 20 Hz to 100 Hz falling linearly to better than 65 dB at 20 kHz (see Figure 6.10).

**Common Mode Rejection (CMR):** (At rated full bandwidth power) See Figure 6.9.

**Voltage Gain:** (With level controls set for maximum output) At the 26 dB gain setting, 20:1  $\pm 3\%$  or 26 dB  $\pm 0.25$  dB.

*Studio Reference I:* At 0.775 volt sensitivity, 103:1  $\pm 12\%$  or 40 dB  $\pm 1$  dB; at 1.4 volt sensitivity 57:1  $\pm 12\%$  or 35 dB  $\pm 1$  dB.

*Studio Reference II:* At 0.775 volt sensitivity, 69:1  $\pm 12\%$  or 37 dB  $\pm 1$  dB; at 1.4 volt sensitivity 38:1  $\pm 12\%$  or 32 dB  $\pm 1$  dB.

### Power

**Power Bandwidth:** (At standard 1 kHz power)

*Studio Reference I:* -1 dB from 5 Hz to 27.5 kHz and -3 dB from 3 Hz to 32.8 kHz.

*Studio Reference II:* -1 dB from 5 Hz to 28.6 kHz and -3 dB from 2.3 Hz to 34.4 kHz.

**Output Power:** *The following are guaranteed minimums for low-distortion 1 kHz power from units configured for 120 VAC, 60 Hz power. For more information on power specifications, see the matrices that follow.*

#### *Studio Reference I*

*Stereo mode (with both channels driven):*

1,160 watts into 4 ohms.

780 watts into 8 ohms.

*Bridge-Mono mode:*

2,220 watts into 8 ohms.

1,580 watts into 16 ohms.

*Parallel-Mono mode:*

2,315 watts into 2 ohms.

1,565 watts into 4 ohms.

#### *Studio Reference II*

*Stereo mode (with both channels driven):*

555 watts into 4 ohms.

355 watts into 8 ohms.

*Bridge-Mono mode:*

1,110 watts into 8 ohms.

715 watts into 16 ohms.

*Parallel-Mono mode:*

1,115 watts into 2 ohms.

710 watts into 4 ohms.

**Load Impedance:** Safe with all types of loads. Rated for 4 to 8 ohms in Stereo mode, 8 to 16 ohms in Bridge-Mono mode, and 2 to 4 ohms in Parallel-Mono mode.

**Required AC Mains:** 50 or 60 Hz; 100, 120, 200, 220 or 240 VAC ( $\pm 10\%$ ). Both units draw 90 watts or less at idle. See Section 7 for detailed information on AC power draw, current draw and thermal dissipation.

*It is extremely important to have adequate AC power for the amplifier. Power amplifiers cannot create energy—they must have the required **voltage and current** to deliver the undistorted rated power you expect.*

### Controls

**Enable:** A front panel push button used to turn the amplifier on and off.

**Level:** A front panel rotary potentiometer for each channel with 31 detents used to control the output level.

**Stereo/Mono:** A three-position back panel switch used to select Stereo, Bridge-Mono and Parallel-Mono mode.

**Sensitivity:** A three-position switch inside the *P.I.P.* compartment used to select the input sensitivity for both channels: 0.775 or 1.4 volts for standard 1 kHz power, or a 26 dB voltage gain.

**Meter On/Off:** A two-position switch behind the front panel used to turn the front panel meters on or off.

**Meter Display Mode:** A two-position switch behind the front panel used to set the display mode for the front panel meters. Display modes include dynamic range of the output signal in dB or output levels in dB.

**Ground Lift:** A two-position back panel switch used to isolate the input phone jack and AC (chassis) grounds.

**Reset:** A two-position back panel switch used to reset the AC mains circuit breaker.

## Indicators

**Enable:** This indicator shows the on/off status of the unit's low-voltage power supply.

**Signal:** Each channel has a signal indicator that flashes to show audio output.

**IOC:** Each channel has an *IOC* indicator that flashes if the output waveform differs from the input waveform by 0.05% or more. The LEDs act as sensitive distortion indicators to provide *proof of distortion-free performance*. In Parallel-Mono mode the channel 2 *IOC* light stays on.

**ODEP:** Each channel has an *ODEP* indicator that shows the channel's reserve energy status. Normally, the LEDs are brightly lit to show that reserve energy is available. In the rare event that a channel has no reserve, its indicator will dim in proportion to *ODEP* limiting. An *ODEP* indicator may also turn off under other more unusual circumstances (see Section 4.3).

**Dynamic Range/Level Meter:** Each channel has a five-segment meter that displays either the dynamic range of the output signal in dB or the output level in dB. (From the factory, the amplifier is set to display dynamic range.) As dynamic range meters, they show the ratio of the peak to average power of each channel. As output level meters they show how high the output levels are relative to standard 1 kHz power.

## Input/Output

**Input Connector:** Two balanced phone jacks on the back panel and two balanced three-pin XLR connectors on the factory-installed *P.I.P.-FX* (see Section 8 for information on optional *P.I.P.* modules).

**Input Impedance:** Nominally 10 K ohms, balanced. Nominally 5 K ohms, unbalanced.

**Input Sensitivity:** Settings include 0.775 volts or 1.4 volts for standard 1 kHz power, or a 26 dB voltage gain (see Section 4.4 for more information).

**Output Connectors:** Two sets of color-coded 5-way binding posts for each channel (for connecting banana plugs, spade lugs or bare wire).

**Output Impedance:** Less than 10 milliohms in series with 2.5 microhenries.

**DC Output Offset:** (Shorted input)  $\pm 2$  millivolts.

## Output Signal

**Stereo:** Unbalanced, two-channel.

**Bridge-Mono:** Balanced, single-channel. Channel 1 controls are active; channel 2 should be turned down.

**Parallel-Mono:** Unbalanced, single-channel. Channel 1 controls are active; channel 2 is bypassed.

## Protection

If unreasonable operating conditions occur, the protection circuitry limits the drive level to protect the output stages especially in the case of elevated temperature. Transformer overheating will result in a temporary shut-down. Controlled slew-rate voltage amplifiers protect the unit against RF burnouts. Input overload protection is furnished at the amplifier input to limit current.

**Turn On:** The four second turn-on delay prevents dangerous turn-on transients. To change the turn-on delay time, contact Crown's Technical Support Group.

## Construction

Steel chassis with durable black finish, aluminum front panel with super-gloss Imron® finish, Lexan overlay, and a specially designed flow-through ventilation system from front to side panels.

**Cooling:** Convection cooling with assistance from the computerized, on-demand proportional cooling fan.

**Dimensions:** Standard 19 inch (48.3 cm) rack mount width (EIA RS-310-B), 7 inch (17.8 cm) height, 16 inch (40.6 cm) depth behind mounting surface and 2.75 inch (7 cm) protrusion in front of mounting surface.

**Approximate Weight:** Center of gravity is about 6 inches (15.2 cm) behind the front mounting surface.

*Studio Reference I:* 60 pounds, 11 ounces (27.6 kg) net; 74 pounds, 3 ounces (33.7 kg) shipping weight.

*Studio Reference II:* 56 pounds, 2 ounces (25.5 kg) net; 69 pounds, 10 ounces (31.6 kg) shipping weight.

*Crown specifications are guaranteed for three years.*

In an effort to provide you with as much information as possible about the high power-producing capabilities of your amplifier, we have created the following power matrices.

**Minimum Guaranteed Power Specifications**

Crown’s minimum power specifications represent the absolute smallest amount of output power you can expect from your amplifier when it is driven to full output under the given conditions. Some spaces in each matrix may be left blank because the same guarantee is not provided for those conditions—however, your amplifier will perform well under all conditions listed in each matrix.

When measuring power, 0.1% THD appears to be the industry standard for distortion. Two of the maximum average power specifications shown in each minimum power matrix are measured at 0.1% THD so you can easily compare Crown specifications to those of other manufacturers. But this high level of distortion actually allows for some clipping which is undesirable. Because of this, a maximum average power specification at 0.05% THD is included in each minimum power matrix which represents non-clipped conditions. Also, power at 0.02% THD is provided in the preceding specifications. Although most manufacturers do not give power specifications at 0.05% or 0.02% THD, we encourage them to provide these specifications so you will have a more realistic representation of the way amplifiers should be used in the real world—without a clipped output signal.

Many manufacturers publish power specs with a tolerance of ±1 dB or worse. This means their amplifier can deviate more than 20% in output! A 100 watt amplifier would meet their specification if it only produced 79.4 watts. Other manufacturers qualify their specs by saying they are “typical,” “subject to manufacturing tolerances,” “single channel driven” or that they are specified with “fuses bypassed.” Each of these statements effectively removes any performance guarantee. In fact, some manufacturers use these tactics to generate large power numbers, and they don’t even print a disclaimer. We take a different approach at Crown—our amplifiers are *guaranteed* to meet or exceed their specifications for three years. Further, because our published

specs are set below our “in-house” measurements, you can expect every Crown amplifier to exceed its published minimum power specs. We believe you should get what you pay for.

**Minimum Power Notes:**

All minimum power specifications are based on 0.5% regulated AC mains with THD of less than 1.0% and an ambient room temperature of 70° F (21° C). Standard EIA power (RS-490) is not shown here because it is identical to FTC Continuous Average Power.

1. A 1 kHz sine wave is presented to the amplifier and the output monitored for nonlinear distortion. The level is increased until THD reaches 0.1%. At this point, average power per channel is reported.
2. A sine wave is presented to the amplifier over the range from 20 Hz to 20 kHz and the output monitored for nonlinear distortion. The level at each frequency is increased until THD reaches 0.1%. At this point, average power per channel is reported.
3. A 1 kHz sine wave is presented to the amplifier and the output monitored for nonlinear distortion. The level is increased until THD reaches 0.05%. At this point, average power per channel is reported.
4. Continuous power in the context of Federal Trade Commission testing is understood to be a minimum of five minutes of operation. Harmonic distortion is measured as the RMS sum total and given as a percentage of the fundamental output voltage. This applies for all wattages greater than 0.25 watts.

Studio Reference I – Minimum Guaranteed Power (Watts)							
AC Mains	Stereo/Mono Mode	Load (Ohms)	Maximum Average			FTC Continuous Average	
			0.1% THD+N (See note 1)	0.1% THD+N (See note 2)	0.05% THD+N (See note 3)	0.1% THD + Noise (See note 4)	
			1 kHz	20Hz-20kHz	1 kHz	1 kHz	20Hz-20kHz
120 VAC, 60 Hz	Stereo (both channels driven)	4	1,190	1,075	1,170		
		8	800	760	790	785	750
	Bridge-Mono (balanced output)	8	2,375	2,150	2,335		
		16	1,595	1,535	1,580	1,575	1,490
	Parallel-Mono	2	2,350		2,320		
		4	1,580		1,565	1,565	
100 VAC, 50 Hz	Stereo (both channels driven)	4	1,095	970	1,075		
		8	750	725	745	750	715
	Bridge-Mono (balanced output)	8	2,200	1,985	2,160		
		16	1,515	1,440	1,495	1,515	1,440
	Parallel-Mono	2	2,185		2,175		
		4	1,500		1,480	1,490	
240 VAC, 50 Hz	Stereo (both channels driven)	4	1,255	1,135	1,255		
		8	825	820	815	820	795
	Bridge-Mono (balanced output)	8	2,505	2,280	2,460		
		16	1,660	1,610	1,645	1,660	1,595
	Parallel-Mono	2	2,485		2,475		
		4	1,655		1,640	1,640	

Fig. 6.1 Studio Reference I Minimum Power Matrix

Studio Reference II – Minimum Guaranteed Power (Watts)							
AC Mains	Stereo/Mono Mode	Load (Ohms)	Maximum Average			FTC Continuous Average	
			0.1% THD+N (See note 1)	0.1% THD+N (See note 2)	0.05% THD+N (See note 3)	0.1% THD + Noise (See note 4)	
			1 kHz	20Hz-20kHz	1 kHz	1 kHz	20Hz-20kHz
120 VAC, 60 Hz	<b>Stereo</b> (both channels driven)	4	565	495	560	555	470
		8	360	340	355	360	340
	<b>Bridge-Mono</b> (balanced output)	8	1,145	1,020	1,130	1,105	960
		16	720	690	715	720	680
	<b>Parallel-Mono</b>	2	1,135		1,125	1,105	
		4	715		715	715	
100 VAC, 50 Hz	<b>Stereo</b> (both channels driven)	4	535	460	525	520	440
		8	355	330	340	345	320
	<b>Bridge-Mono</b> (balanced output)	8	1,080	970	1,070	1,045	900
		16	700	665	695	690	655
	<b>Parallel-Mono</b>	2	1,065		1,055	1,030	
		4	690		685	675	
240 VAC, 50 Hz	<b>Stereo</b> (both channels driven)	4	595	520	585	580	465
		8	375	360	370	375	355
	<b>Bridge-Mono</b> (balanced output)	8	1,205	1,060	1,195	1,145	915
		16	755	720	750	740	700
	<b>Parallel-Mono</b>	2	1,190		1,175	1,155	
		4	755		745	735	

Fig. 6.2 Studio Reference II Minimum Power Matrix

### Maximum Power Specifications

Crown’s maximum power specifications represent the largest amount of output power you can expect from your amplifier when it is driven to full output under the given conditions. These specifications can be used to prevent loudspeaker and hearing damage.

The maximum power matrices include specifications for single cycle and 40 millisecond burst sine waves. Burst signals act like large transient peaks that are present in common source signals. Loudspeakers can respond to a single cycle burst, so the single cycle burst specifications should be used to help you protect your loudspeakers. In contrast, a 40 millisecond burst represents the typical response time of the human ear. Your ear will not respond to the entire dynamic change of a burst that lasts less than 40 milliseconds.

The burst power specifications are provided at 0.05% THD which is a practical low distortion condition. Operating the amplifier at levels higher than 0.05% THD can result in output power levels that are higher than those listed in the maximum power matrices.

Studio Reference I – Maximum Power (Watts)								
AC Mains	Stereo/Mono Mode	Load (Ohms)	Single Cycle Tone Burst 0.05% Distortion + Noise (See note 1)			40 Millisecond Tone Burst 0.05% Distortion + Noise (See note 2)		
			50 Hz	1 kHz	7 kHz	50 Hz	1 kHz	7 kHz
			120 VAC, 60 Hz	Stereo (both channels driven)	4	1,435	2,180	2,030
8	900	1,165			1,120	835	820	830
Bridge-Mono (balanced output)	8	2,855		4,355	4,080	2,635	2,425	2,400
	16	1,780		2,345	2,215	1,695	1,635	1,650
Parallel-Mono	2	2,820		4,380	4,075	2,605	2,420	2,395
	4	1,795		2,340	2,230	1,700	1,620	1,650
100 VAC, 50 Hz	Stereo (both channels driven)	4	1,380	2,150	2,015	1,260	1,135	1,135
		8	900	1,155	1,100	820	780	790
	Bridge-Mono (balanced output)	8	2,780	4,285	4,020	2,595	2,260	2,235
		16	1,740	2,320	2,195	1,600	1,555	1,570
	Parallel-Mono	2	2,780	4,325	3,985	2,455	2,250	2,250
		4	1,780	2,320	2,190	1,620	1,545	1,575
240 VAC, 50 Hz	Stereo (both channels driven)	4	1,470	2,220	2,065	1,370	1,290	1,275
		8	930	1,190	1,135	880	850	860
	Bridge-Mono (balanced output)	8	2,945	4,360	4,090	2,695	2,560	2,505
		16	1,830	2,360	2,250	1,750	1,685	1,705
	Parallel-Mono	2	2,970	4,415	4,100	2,715	2,525	2,550
		4	1,810	2,355	2,240	1,745	1,685	1,700

Fig. 6.3 Studio Reference I Maximum Power Matrix

### Maximum Power Notes:

All maximum power specifications are based on 0.5% regulated AC mains with THD of less than 1.0% and an ambient room temperature of 70° F (21° C). Although it is an unusual condition, your amplifier can function well with AC mains voltages up to 10% over the specified line voltage. With overvoltage conditions, your amplifier may be capable of delivering instantaneous power levels up to 20% greater than the specifications in the matrix.

1. A single cycle sine wave is presented to the amplifier and monitored for nonlinear distortion. The average power during the burst is reported. Loudspeakers must be able to withstand this level if they are to be safely used with this amplifier.
2. A 40 millisecond sine wave burst (10 percent duty cycle) is presented to the amplifier and monitored for nonlinear distortion. Average power during the burst is reported. This power level is a measurement of the amplifier’s maximum transient power that can be perceived by the human ear.

Studio Reference II – Maximum Power (Watts)								
AC Mains	Stereo/Mono Mode	Load (Ohms)	Single Cycle Tone Burst 0.05% Distortion + Noise (See note 1)			40 Millisecond Tone Burst 0.05% Distortion + Noise (See note 2)		
			50 Hz	1 kHz	7 kHz	50 Hz	1 kHz	7 kHz
			120 VAC, 60 Hz	Stereo (both channels driven)	4	630	875	820
8	395	480			455	375	370	375
Bridge-Mono (balanced output)	8	1,345		1,785	1,685	1,245	1,185	1,185
	16	800		970	935	750	755	770
Parallel-Mono	2	1,330		1,770	1,670	1,205	1,170	1,170
	4	790		965	920	755	745	765
100 VAC, 50 Hz	Stereo (both channels driven)	4	690	905	855	650	610	610
		8	405	495	470	385	385	395
	Bridge-Mono (balanced output)	8	1,395	1,840	1,750	1,315	1,230	1,240
		16	830	1,005	965	785	780	800
	Parallel-Mono	2	1,405	1,830	1,730	1,330	1,220	1,220
		4	815	995	955	785	770	790
240 VAC, 50 Hz	Stereo (both channels driven)	4	650	880	830	595	565	565
		8	365	450	430	345	340	350
	Bridge-Mono (balanced output)	8	1,305	1,775	1,715	1,195	1,130	1,150
		16	790	965	940	735	735	755
	Parallel-Mono	2	1,295	1,765	1,655	1,185	1,120	1,130
		4	785	965	920	750	725	745

Fig. 6.4 Studio Reference II Maximum Power Matrix



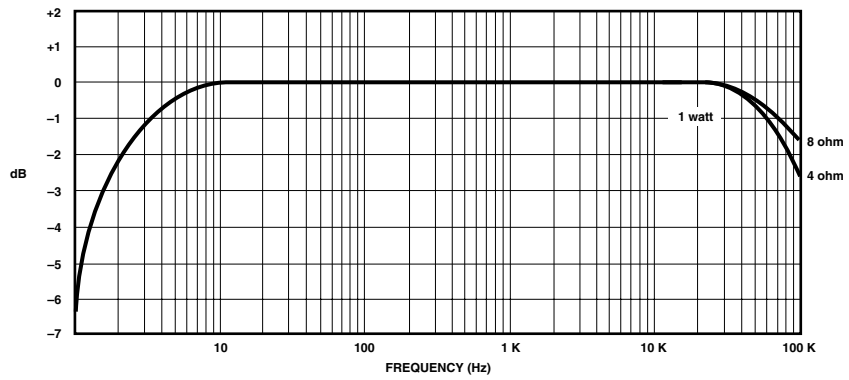

Fig. 6.5 Typical Frequency Response

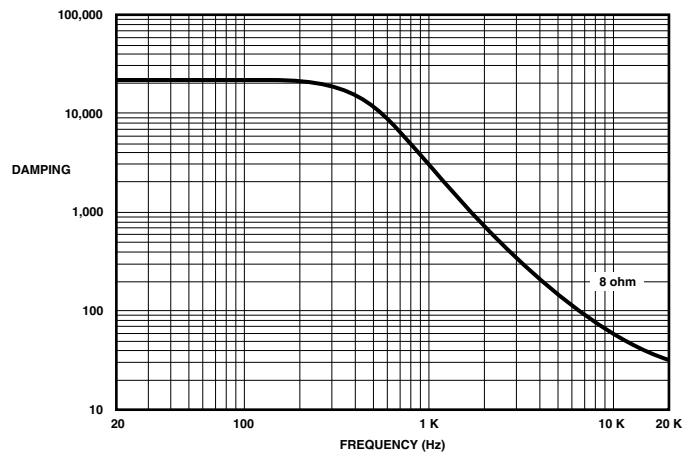

Fig. 6.6 Typical Damping Factor

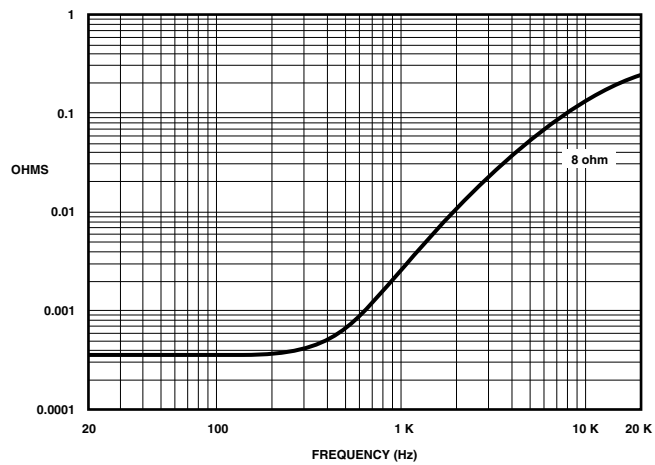

Fig. 6.7 Typical Output Impedance

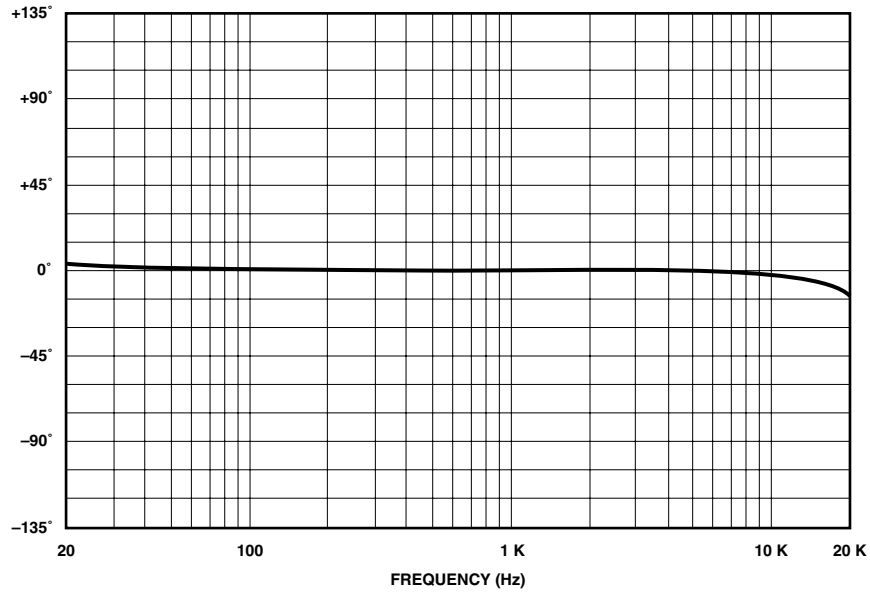

Fig. 6.8 Typical Phase Response

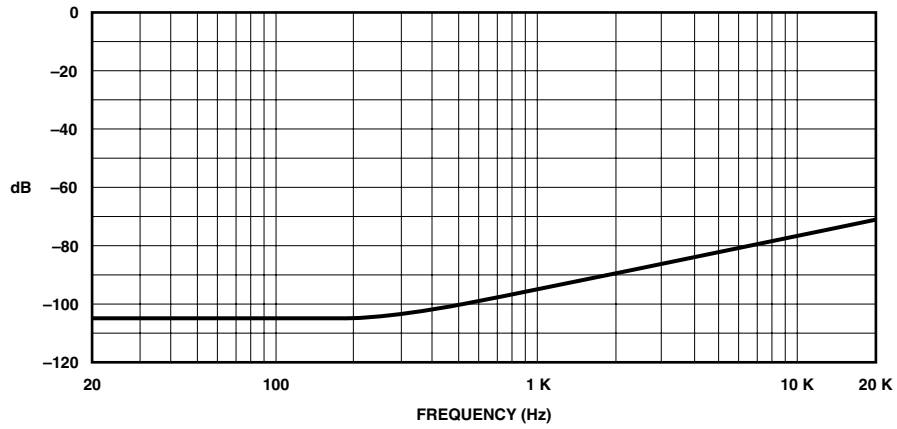

Fig. 6.9 Typical Common Mode Rejection

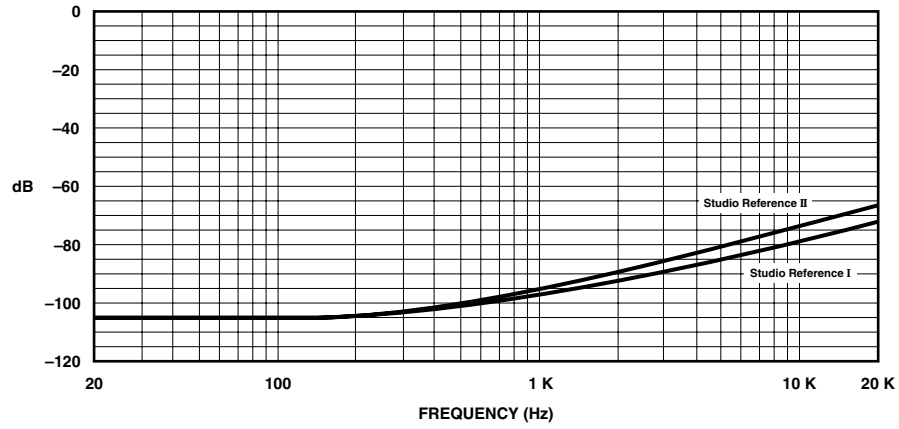

Fig. 6.10 Typical Crosstalk

## 7 AC Power Draw and Thermal Dissipation

This section provides detailed information about the amount of power and current drawn from the AC mains by *Studio Reference* amplifiers and the amount of heat produced under various conditions. The calculations presented here are intended to provide a very realistic and reliable depiction of the amplifiers. The following assumptions were made:

- The amplifier’s available channels are loaded, and full, standard 1 kHz power is being delivered.
- Amplifier efficiency at standard 1 kHz power is estimated to be 65%.
- Quiescent power draw is 90 watts (an almost negligible amount for full-power calculations).
- Quiescent thermal dissipation equals 307 btu/hr at 90 watts.
- Duty cycle takes into account the typical crest factor for a particular type of source material.
- Duty cycle of pink noise is 50%.
- Duty cycle of highly compressed rock ‘n’ roll midrange is 40%.
- Duty cycle of uncompressed rock ‘n’ roll is 30%.
- Duty cycle of background music is 20%.
- Duty cycle of continuous speech is 10%.
- Duty cycle of infrequent paging is 1%.

Here are the equations used to calculate the data presented in Figures 7.1 and 7.2:

$$\text{AC Mains Power Draw (watts)} = \frac{\text{Total output power with all channels driven (watts)} \times \text{Duty Cycle}}{\text{Amplifier Efficiency (.65)}} + \text{Quiescent Power Draw (90 watts)}$$

The estimated quiescent power draw of 90 watts is a maximum figure, and assumes the fan is running at high speed. The following equation converts power draw in watts to current draw in amperes:

$$\text{Current Draw (amperes)} = \frac{\text{AC Mains Power Draw (watts)}}{\text{AC Mains Voltage} \times \text{Power Factor (.83)}}$$

The power factor constant of 0.83 is needed to compensate for the difference in phase between in the AC mains voltage and current. The following equation was used to calculate thermal dissipation:

$$\text{Thermal Dissipation (btu/hr)} = \left( \frac{\text{Total output power with all channels driven (watts)} \times \text{Duty Cycle} \times .35}{\text{Amplifier Efficiency (.65)}} + \text{Quiescent Power Draw (90 watts)} \right) \times 3.415$$

The constant 0.35 is inefficiency (1.00 – 0.65) and the factor 3.415 converts watts to btu/hr. Thermal dissipation in btu is divided by the constant 3.968 to get kcal. If you plan to measure output power under real-world conditions, the following equation may be helpful:

$$\text{Thermal Dissipation (btu/hr)} = \left( \frac{\text{Total output power with all channels driven (watts)} \times \text{Duty Cycle} \times .35}{\text{Amplifier Efficiency (.65)}} + \text{Quiescent Power Draw (90 watts)} \right) \times 3.415$$

**Studio Reference I**

Duty Cycle	L O A D									
	AC Mains Power Draw (Watts)	8 Ohm Stereo / 16 Ohm Bridge-Mono / 4 Ohm Parallel-Mono				4 Ohm Stereo / 8 Ohm Bridge-Mono / 2 Ohm Parallel-Mono				Thermal Dissipation
		100-120 V	220-240 V	btu/hr	kcal/hr	AC Mains Power Draw (Watts)	100-120 V	220-240 V	btu/hr	
50%	1325	15.9	7.2	1,780	450	1,925	23.1	10.5	2,500	630
40%	1075	12.9	5.9	1,485	375	1,555	18.7	8.5	2,060	520
30%	830	10.0	4.5	1,190	300	1,190	14.3	6.5	1,620	410
20%	585	7.0	3.2	900	230	825	9.9	4.5	1,185	300
10%	340	4.1	1.8	605	155	460	5.5	2.5	745	190

Fig. 7.1 *Studio Reference I* Power Draw, Current Draw and Thermal Dissipation at Various Duty Cycles

**Studio Reference II**

Duty Cycle	L O A D									
	AC Mains Power Draw (Watts)	8 Ohm Stereo / 16 Ohm Bridge-Mono / 4 Ohm Parallel-Mono				4 Ohm Stereo / 8 Ohm Bridge-Mono / 2 Ohm Parallel-Mono				
		Current Draw (Amps)		Thermal Dissipation		AC Mains Power Draw (Watts)	Current Draw (Amps)		Thermal Dissipation	
	100-120 V	220-240 V	btu/hr	kcal/hr			100-120 V	220-240 V	btu/hr	kcal/hr
50%	645	7.8	3.5	970	245	975	11.7	5.3	1,360	345
40%	535	6.4	2.9	840	215	795	9.6	4.4	1,150	290
30%	425	5.1	2.3	705	180	620	7.5	3.4	940	240
20%	315	3.8	1.7	575	145	445	5.3	2.4	730	185
10%	205	2.4	1.1	440	115	270	3.2	1.5	520	135

Fig. 7.2 Studio Reference II Power Draw, Current Draw and Thermal Dissipation at Various Duty Cycles

## 8 Accessories

### 8.1 P.I.P. Modules

One advantage of *Studio Reference* amplifiers is the ability to customize them using *P.I.P.* (Programmable Input Processor) modules. Each amplifier is equipped with an edge card connector inside the back panel *P.I.P.* compartment. The modules install easily:

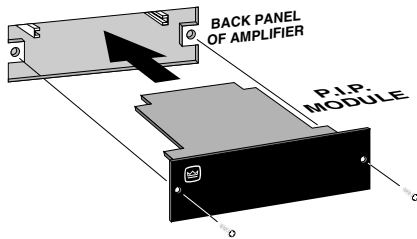
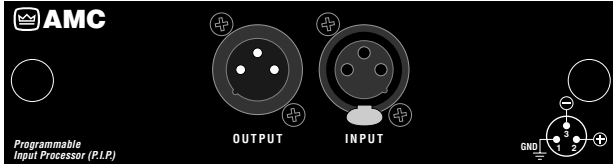

Fig. 8.1 Installing a P.I.P. Module

**WARNING:** Disconnect power to the amplifier when installing or removing a *P.I.P.* module.

Here are some of the available *P.I.P.* modules:



*P.I.P.-AMCb* unites many features of the *P.I.P.-XOV* and *P.I.P.-CLP*. It offers a variable 4th-order Linkwitz-Riley crossover and an *IOC*-driven, variable threshold compressor. In addition, it provides “constant-directivity” horn equalization and filter-assisted  $B_6$  vented box equalization. Biamping and triamping capabilities are provided via XLR connectors.

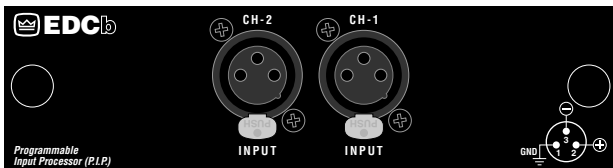

*P.I.P.-EDCb* combines a sophisticated error-driven compressor and smooth limiter with a subsonic filter for each channel. The compressors have adjustable attack and release times, and can be set to track each other. The

compressors activate when a signal will clip the input, an *IOC* error occurs, or the output exceeds the selected threshold. The subsonic filters have corner frequencies of 24, 28, 32 and 36 Hz.

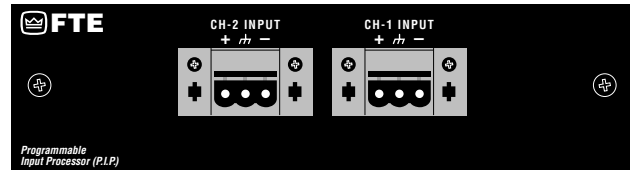

*P.I.P.-FTE* includes all *P.I.P.-FXT* features, and adds 12 dB/octave RFI filters, variable 18 dB/octave high-pass filters, and 6 dB/octave 3 kHz shelving networks for “constant-directivity” horn equalization. Screw terminal plugs are provided for input.

*IQ-P.I.P.-AP* integrates the amplifier into Crown's patented *IQ System*®. The *IQ System* provides centralized computer control of 1 to 2,000 amplifiers. Each amplifier channel can be monitored and controlled from an inexpensive personal computer. Any combination of mic- and line-level signals can also be mixed and routed with optional *MPX-6*™, *SMX-6*™ and *AMB-5*™ mixer/multiplexers, and the *MRX* series matrixers.

*IQ-P.I.P.-AP Smart Amp*™ offers the monitoring and control features of the *IQ-P.I.P.-AP* plus the ability to function as a stand-alone unit as part of the *IQ System's distributed intelligence*™. Features include a smooth output limiter for transparent loudspeaker protection, power supply gates for energy savings, *ODEP* conservation which protects the output devices with precision input signal control, interrupt-driven reporting that lets you define error conditions, and configurable short detection.

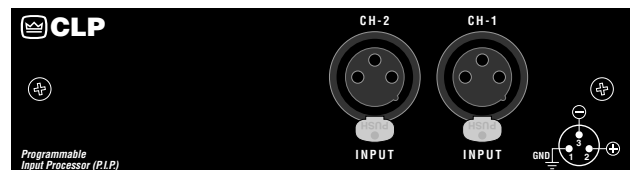

*P.I.P.-CLP* is designed to detect and prevent overload. Its compressor is driven by the amplifier's built-in *IOC* error detection circuitry. Unlike typical signal-driven com-

processors, it only compresses the signal to prevent overload. It can deliver up to 13 dB of additional headroom without being noticeable.

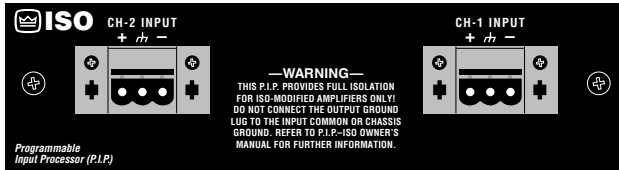

P.I.P.-ISO is designed especially for 25 to 140 volt distributed systems where UL®-listed isolation is required. Installation requires minor amplifier modifications. With the P.I.P.-ISO installed, the amplifier outputs are safely isolated from the input terminals and the chassis.

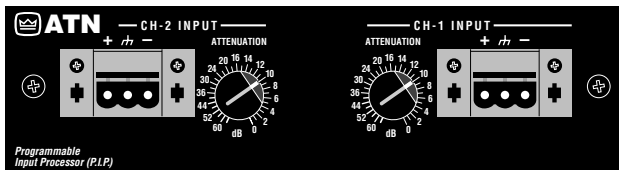

P.I.P.-ATN includes all P.I.P.-FTE features, plus a 32-step precision attenuator for each channel.

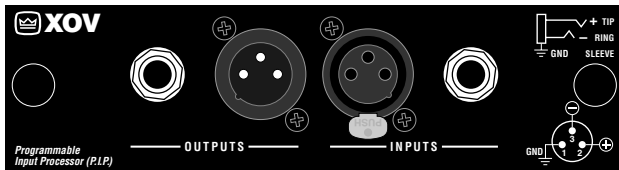

P.I.P.-XOV is a versatile 18 dB/octave mono crossover/filter with biamping and triamping capabilities.

P.I.P.-FMX facilitates “daisy-chaining” balanced amplifier inputs. Female to male three-pin XLR connectors are used to passively bridge the inputs.

P.I.P.-FXQ makes it easy to connect audio sources that have phono (RCA) connectors. It includes two balanced three-pin female XLR connectors, and two female phono jacks for quasi-balanced or unbalanced operation.

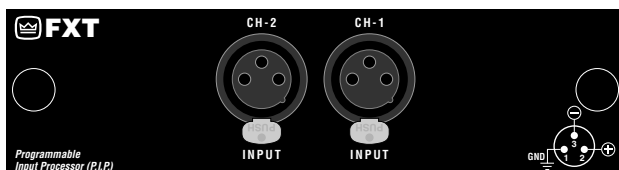

P.I.P.-FXT uses balanced 1:1 transformers to isolate the amplifier from the input signal. It has balanced female three-pin XLR connectors.

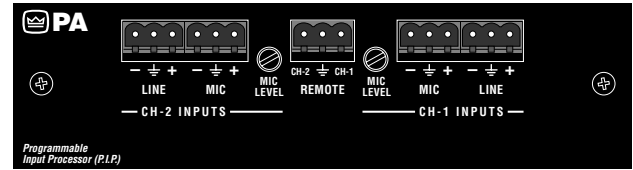

P.I.P.-PA adds a switchable balanced low-impedance mic input, a balanced line-level input and a compressor to each channel. Remote switching circuitry provides quick and quiet fades from mic to line and back.

P.I.P.-102 is a two-channel module providing equalization based on the BOSE® 102 controller. Screw terminal plugs provide balanced connections. Each input channel has an output from the P.I.P. that can be independently configured for output with no processing, 102 equalization or 102 equalization with bass-cut.

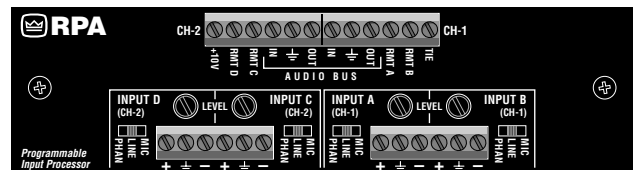

P.I.P.-RPA adds the features of a 4x2 mixer to your amplifier. Its four inputs accept mic- or line-level input. It offers priority switching (“voice-over”) of each input and remote level control with the RPA-RMT. Other features include bus inputs and outputs, adjustable input sensitivity, phantom power and RFI suppression. Input isolation transformers are optional.

For more information on these P.I.P.s or other P.I.P.s under development, contact your local dealer or Crown's Technical Support Group.

## 9 Service

This unit has very sophisticated circuitry which should only be serviced by a fully trained technician. This is one reason why each unit bears the following label:



**CAUTION:** To prevent electric shock, do not remove covers. No user serviceable parts inside. Refer servicing to a qualified technician.

### 9.1 Worldwide Service

Service may be obtained from an authorized service center. (Contact your local Crown/Amcron representative or our office for a list of authorized service centers.) To obtain service, simply present the bill of sale as proof of purchase along with the defective unit to an authorized service center. They will handle the necessary paperwork and repair.

Remember to transport your unit in the original factory pack. We will pay the surface shipping costs both ways for **warranty service** to the authorized service center nearest you after receiving copies of all shipping receipts. You must bear the expense of all taxes, duties, and customs fees when transporting the unit.

### 9.2 North American Service

Service may be obtained in one of two ways: from an authorized service center or from the factory. You may choose either. It is important that you have your copy of the bill of sale as your proof of purchase.

#### 9.2.1 Service at a North American Service Center

This method usually saves the most time and effort. Simply present your bill of sale along with the defective unit to an authorized service center to obtain service. They will handle the necessary paperwork and repair. Remember to transport the unit in the original factory pack. A list of authorized service centers in your area can be obtained from our Technical Support Group.

#### 9.2.2 Factory Service

To obtain factory service, fill out the **service information page** that follows and send it along with your proof of purchase and the defective unit to the Crown factory. For warranty service, we will pay for ground shipping both ways in the United States after receiving copies of the shipping receipts. Shipments should be sent "UPS ground." (If the unit is under warranty, you may send it C.O.D. for the cost of freight via UPS ground.) The factory will return it via UPS ground. Please contact us if other arrangements are required.

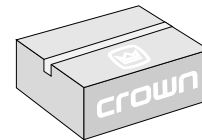

Always use the original factory pack to transport the unit.

#### Factory Service Shipping Instructions:

1. When sending a Crown product to the factory for service, be sure to fill out the service information form that follows and enclose it inside your unit's shipping pack. Do not send the service information form separately.
2. To ensure the safe transportation of your unit to the factory, ship it in an original factory packing container. If you don't have one, call or write Crown's Parts Department. With the exception of polyurethane or wooden crates, any other packing material will not be sufficient to withstand the stress of shipping. Do not use loose, small size packing materials.
3. Do not ship the unit in any kind of cabinet (wood or metal). Ignoring this warning may result in extensive damage to the unit and the cabinet. Accessories are not needed—do not send the instruction manual, cables and other hardware.

If you have any questions, please call or write the Crown Technical Support Group.

**Crown Audio Division**  
Tech. Support / Factory Service  
57620 C.R. 105  
Elkhart, Indiana 46517 U.S.A.

Phone: 1-219-294-8200  
U.S.: 1-800-342-6939  
Fax: 1-219-294-8301



